

**PENTAX®**

Instruction Manual

Electronic Total Station

**R-300** SERIES

**R-315(N)/R-325(N)/R-335(N)  
R-322(N)/R-323(N)/R-326**

**PENTAX Precision Co., Ltd.**

## **Safety Precautions (Must be followed)**

The following items are intended to prevent possible injury to the user or other people and/or damage to the instrument before it occurs. These safety precautions are important to the safe operation of this product and should be observed at all times.

### ■ **Distinctive Displays**

The following displays are used to distinguish precautions by the degree of injury or damage that may result if the precaution is ignored.



### **WARNING**

Items indicated by this display are precautions which if ignored would result in serious injury.



### **CAUTION**

Items indicated by this display are precautions which if ignored may result in injury or material.

- Here “injury” refers to injuries such as cuts, burns or electric shock the treatment of which will not likely require hospitalization or long-term attention.
- “Material damage” refers to damage to facilities, buildings, acquired data, etc.

Before using this product, be sure that you have thoroughly read and understood this instruction manual to ensure proper operation. After reading this manual, be sure to keep it in a convenient place for easy reference.

This instrument complies with the protection requirement for residential and commercial areas. If this instrument is used close to industrial areas or transmitters, the equipment can be influenced by electromagnetic fields.

- Three R-300 Quick Reference Guide are provided in your carrying case. They are 1. Basic Procedures, 2. Power Topo Lite Operating Procedures and 3. PSF Operating Procedures.

**WARNING**

Do not stare into the laser beam directly as this may result in damage to your eyes. R-300 is a Class II Laser product. (The reflectorless type is a Class IIIa (3R) laser product.)



Do not look into the laser radiation aperture directly as this may result in damage to your eyes.



Never use the telescope to view intense light such as direct sunlight or sunlight reflected through a prism as this may result in loss of sight.



Do not disassemble, modify or repair this product as there is a risk of laser radiation.



Do not aim the laser beam at a person as it is harmful to the eyes and body. Receive the examination treatment by the doctor when the eyesight or body trouble is doubted by any chance.

● **Electro-Magnetic Compatibility (EMC):**

This instrument complies with the protection requirement for residential and commercial areas. If this instrument is used close to industrial areas or transmitters, the equipment can be influenced by electromagnetic fields.

- Do not use this product in a coal mine, in a location where there is coal dust, or near flammable material as there is a risk of explosion.
- Do not disassemble, modify or repair this product as there is a risk of fire, electric shock and burn injury. If you think the product requires repair, contact the retail outlet where you purchased it or an authorized repair site.
- Only use the BC03 battery charger intended for this product as the battery charger. Use of another battery charger entails a risk of fire or burn injury from the battery bursting into flames due to possible differences in voltage or polarity.
- Do not use a damaged electric cord plug or loose electric outlet when charging as there is a risk of fire or electric shock.
- Do not charge the battery while covered by clothes or similar item as there is a risk of fire if the clothes ignite.
- Do not use the battery or charger when wet as there is a risk of fire and burn injury due to short-circuit.
- To prevent making short-circuit when removing the battery and charger from the case and storing them, apply electrically resistant tape to the poles of the battery. Storing the battery and charger as-is may result in fire or burn injury due to short-circuit.
- Do not throw the battery into fire or expose it to heat as there is a risk of injury if it explodes.



## CAUTION



For security, please do the opening inspection and inspection every a fixed period and adjustment.



When the laser beam enters eyes, an unexpected accident might be caused by the blink of eyes. Establish the laser product to avoid the height of eyes of a driving person and walker.



Establish an instrument so that laser beam does not hit a reflection thing as a mirror and a glass window. The reflection beam of the laser is also harmful to the human body.



Besides the time when you measure the distance, cut off the power supply or shade the beam of aperture with caps.



Keep the laser product in the place where the person who does not have the product knowledge such as children does not touch by mistake.



Destroy the power supply mechanism of the instrument so as not to emit the laser beam when throwing away it.

- Do not remove the handgrip without good reason. If it does come off, be sure to attach it securely to the instrument with screws. If it is not fastened securely, the instrument may fall when you grasp the handgrip, leading to possible injury.
- Do not short the poles of the battery or charger as there is a risk of injury or fire.
- Do not touch any fluid which may leak from the battery as there is a risk of chemical burn injury or reaction.
- Do not insert or remove the electric plug with wet hands as there is a risk of electric shock.
- Do not use the case to stand on as it is slippery and unstable and may cause you to fall, resulting in possible injury.
- Be sure the tripod itself and the instrument on the tripod are both installed securely as insecure installation may cause the tripod to fall over or the instrument to drop, resulting in possible injury.
- Do not carry the tripod with the metal shoe pointing toward another person as the person may be injured if they strike him or her.



Ni-MH

The instrument contains a rechargeable battery and it is rechargeable. At the end of its useful life, it may be illegal to dispose of the battery. Check with your local solid waste officials for details for recycling.

## **Usage Precautions**

Surveying instruments are high-precision instruments. In order to assure that the Electronic Total Station R-300 series product which you have purchased will provide long-lasting maximum performance, the precautions in this manual must be followed. Be sure to follow these instructions and use this product properly at all times.

### [Solar Observation]



## **WARNING**

Never view the sun directly using the telescope as this may result in loss of sight. Never point the objective lens directly at the sun as this may damage internal components. When using the instrument for solar observation, be sure to attach the special solar filter (MU64) designed for this product to the objective lens.

### [Laser Beam]



Do not stare into laser beam. R-300 is a class-II Laser product. (The reflectorless type is a Class IIIa (3R) laser product.)

### [EDM axis]

The R series EDM is the red visible laser beam and the beam diameter is very small. The beam is emitted from the objective center and the base plate center hole. The EDM axis is designed to coincide with the telescope sight axis but both axes may not sometimes coincide slightly according to the intense temperature change and time lapse.

### [Target Constant]

Confirm the Target Constant of the instrument before measurement.

If a different constant is to be used, use the correct constant of the target. The constant is stored in the instrument's memory when turned off.

### [Reflectorless and Reflector sheet]

- The measurement range is determined by the white side of the Kodak Gray Card facing the instrument and by its surrounding brightness.  
There is a possibility that the range may vary when the target does not satisfy the conditions above at survey work.
  - Pay attention to following in case of distance measurement by Reflectorless. In a situation resulting in low accuracy, perform the distance measurement by Reflector sheet or Prism. (R-315N/R-325N/R-335N/R-322N/R-323N)
- ① There is a possibility that correct distance measurement may be impossible by dispersion or reduction of laser beam when the laser beam comes into the target from diagonal angle.
  - ② There is a possibility that the instrument cannot calculate correctly when receiving reflected laser beam from forth and back directions in case of measuring the target on the road.

## PRECAUTIONS REGARDING SAFETY

- ③ There is a possibility that synthesized values are calculated and the distance may become longer or shorter than the actual one when the operator measure the target of slope or sphere or gurged shape.
  - ④ There is a possibility that the instrument cannot calculate correctly by collecting the reflected laser beam from a man or a car that comes and goes in front of the target.
- When using Reflector sheet, set the Reflector sheet to have its surface be approx. vertical to the aiming line. If it is positioned not to be approx. right angle, there is a possibility that correct distance measurement may be impossible by dispersion or reduction of laser beam.

### [Battery & Charger]

- Never use any battery charger other than the BC03 battery charger as this may result in damage to the instrument.
- If water should happen to splash on the instrument or the battery, wipe it off immediately and allow it to dry in a dry location. Do not put the instrument in the case until it is completely dry as this may result in damage to the instrument.
- Turn off the power when removing the battery from the instrument as removing the battery while the power is still on may result in damage to the instrument.
- The battery mark displayed on the instrument is only an estimate of remaining battery power and is not completely accurate. Replace the battery quickly when it is about to run down as the time a battery lasts on one charge differs depending on conditions of ambient temperature, and the measurement mode of the instrument.
- Confirm the battery level remaining before operating.

### [Auto focus]

- The Auto focus mechanism is very precise but will not function under every condition. Focusing depends on brightness, contrast, the shape and size of the target.  
In such a case, press the AF button and focus on the target by operating the Power focus key or the Focusing knob.
- The R-326 has no Auto focus function.

### [LD POINT, Laser pointer]

When you make a correct direction using the "LD POINT", aim the laser beam at the wall and mark the center and then confirm the discrepancy between the reticle center and the marked point beforehand.

## [Storage and Operating Environment]

- To prevent making short-circuit when removing the battery and charger from the case and storing them, apply electrically resistant tape to the poles of the battery. Storing the battery and charger as is may result in fire or burn injury due to short-circuit.
- Avoid storing the instrument in places subject to extreme high, low or radically fluctuating temperature. (Ambient temperature range during use:  $-20^{\circ}\text{C}$  to  $+50^{\circ}\text{C}$ )
- Distance measurements may take longer when atmospheric conditions are poor such as when heat shimmer is present. When storing the instrument, always put it in its case and avoid storage in dusty location or location subject to vibration or extreme heat or humidity.
- Whenever there is a sharp temperature difference between the instrument's storage and usage locations allow the instrument to adjust to the ambient for an hour or more before use. Be sure to protect the instrument from the sun if the location is subject to intense direct sunlight.
- During surveys for which the survey precision or atmospheric measurement method has been defined measure the atmospheric temperature and pressure separately and enter those values rather than using the Automatic Atmospheric Correction function.
- The battery should be charged approximately once per month if the instrument is to be stored for an extended period of time. The instrument should also be removed from its case occasionally and aired out.
- In addition to these precautions, be sure to handle the instrument properly at all times following the descriptions given in the various sections of this manual to assure safe and proper measurements.

## [Transporting and Carrying the Instrument]

- Be careful to protect this instrument from shock of impact and excessive vibration which may result in damage during transportation and shipment.
- When transporting the instrument, always put it in the case and wrap shock-absorbing material around it and be sure it is handled as "FRAGILE".

## [Checks and Repairs]

- Always check the instrument before beginning work and check that the instrument is maintaining the proper level of precision. Pentax bears absolutely no responsibility for damages due to survey results obtained from surveys conducted without an initial instrument check.
- Never disassemble the instrument, battery or charger even if you do detect an abnormality as there is a risk of fire or electric shock due to short-circuit. If you think the product requires repair, contact the retail outlet where you purchased it or an authorized repair site.

## CONTENTS

### PRECAUTIONS REGARDING SAFETY

Safety Precautions .....	1
Usage Precautions .....	3

### 1 BEFORE USING THE INSTRUMENT

1-1 Names of Parts .....	9
1-2 Unpacking and Packing .....	11
1-3 Standard equipment .....	11
1-4 Attaching and Charging the Battery .....	12

### 2 DISPLAY AND KEYBOARD

2-1 Display and Keyboard .....	16
2-2 Operation Key .....	16
2-3 Function Key .....	17
2-4 Alphanumeric Input .....	19
2-5 LD POINT, Laser pointer .....	19

### 3 PREPARATION FOR SURVEYING

3-1 Centering and Leveling of the Instrument .....	20
3-2 Laser plummet .....	20
3-3 Optical plummet (Option) .....	22
3-4 Leveling with Circular vial .....	23
3-5 Leveling with Electronic vial .....	23
3-6 Eyepiece Adjustment .....	25
3-7 Target Sighting .....	26
3-8 Attachment and Detachment of Tribrach .....	32

### 4 TURNING THE POWER ON

4-1 Turning the Power On and Off .....	33
4-2 Adjusting LCD Contrast .....	34
4-3 Adjusting Illumination Brightness .....	35
4-4 Adjusting Reticle Illumination .....	35

### 5 ANGLE MEASUREMENT

5-1 Measuring an Angle .....	36
5-2 Resetting the Horizontal Angle to 0 .....	37
5-3 Holding the Horizontal Angle .....	37
5-4 Inputting an Arbitrary Horizontal Angle .....	38
5-5 Displaying the % Slope of the Vertical Angle .....	40
5-6 Changing the Horizontal Angle from Clockwise to Counterclockwise .....	41



<b>6</b>	<b>DISTANCE MEASUREMENT</b>	
6-1	Target Setting .....	42
6-2	Distance Measurement .....	44
<b>7</b>	<b>CORRECTION MODE</b>	
7-1	Changing the Target Constant .....	46
7-2	Changing the Temperature .....	48
7-3	Changing the Atmospheric Pressure .....	50
7-4	Changing the ppm Value .....	52
<b>8</b>	<b>INITIAL SETTING</b>	
8-1	Overview .....	53
8-2	Entering the Mode for Initial Setting 1 .....	53
8-3	Entering the Mode for Initial Setting 2 .....	53
8-4	Entering the Mode for Initial Setting 4 .....	54
8-5	Entering the Mode for Initial Setting 5 .....	54
8-6	Example of Changing an Initial Setting Content .....	55
8-7	Initial Setting 1 .....	56
8-8	Initial Setting 2 .....	57
8-9	Initial Setting 4 .....	60
8-10	Initial Setting 5 .....	61
<b>9</b>	<b>ACCESSING THE FUNCTIONS</b>	
9-1	Accessing by Help key .....	62
9-2	Accessing by 007 .....	63
<b>10</b>	<b>CHECKS AND ADJUSTMENTS</b>	
10-1	Electronic Vial .....	65
10-2	Circular Vial .....	67
10-3	Vertical Reticle .....	68
10-4	Perpendicularity of Line of sight to horizontal axis .....	69
10-5	Vertical 0 point error .....	70
10-6	Laser Plummet .....	71
10-7	Optical Plummet .....	72
10-8	Offset Constant .....	73
10-9	Beam axis and Line of sight .....	74
10-10	The EDM beam axis .....	74
<b>11</b>	<b>SPECIFICATIONS</b>	
<b>12</b>	<b>DATA COLLECTOR</b>	

## CONTENTS

### 13 APPENDIX

13-1	Error Messages .....	79
13-2	Atmospheric Correction .....	80
13-3	hPa and mmHg Conversion Tables .....	81
13-4	Error when no Atmospheric Correction is made .....	82
13-5	Atmospheric Refraction and Earth Curvature Correction .....	83
13-6	Distance Range .....	84

### 14 NOTICE TO THE USER OF THIS PRODUCT

# 1 BEFORE USING THE INSTRUMENT

## 1-1 Names of Parts

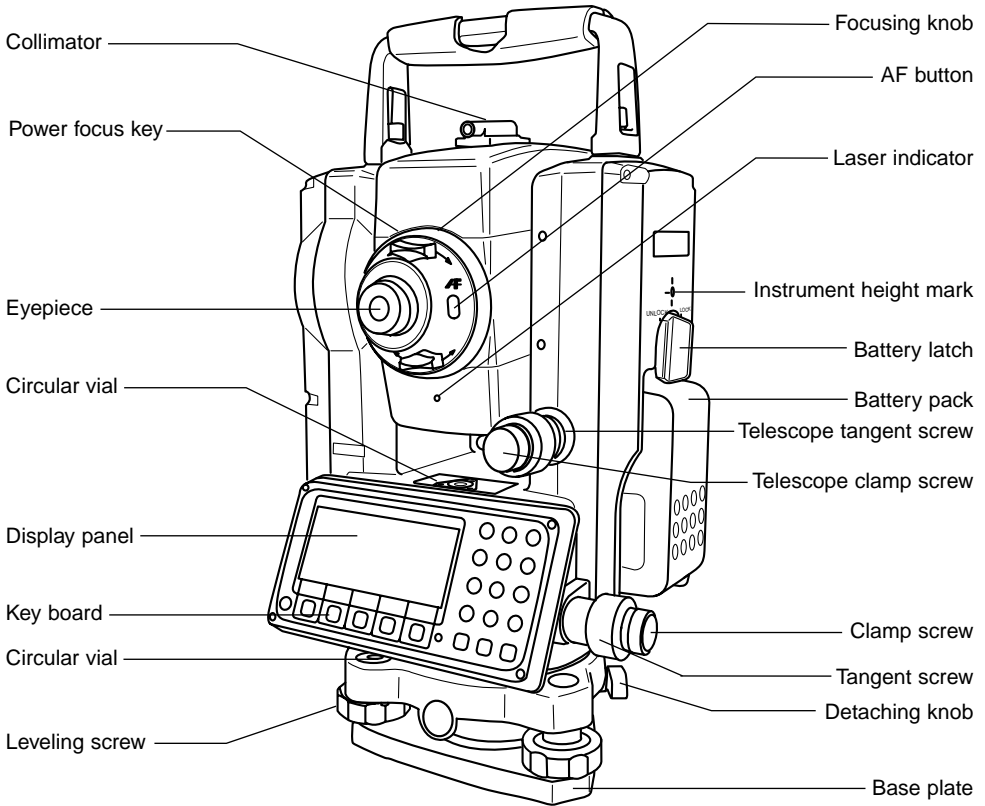

R-325(N)/R-322(N)/R-323(N): Detachable type

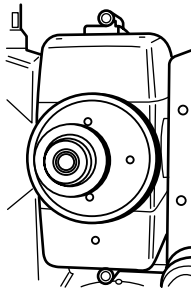

Eyepiece section of R-326.

# 1 BEFORE USING THE INSTRUMENT

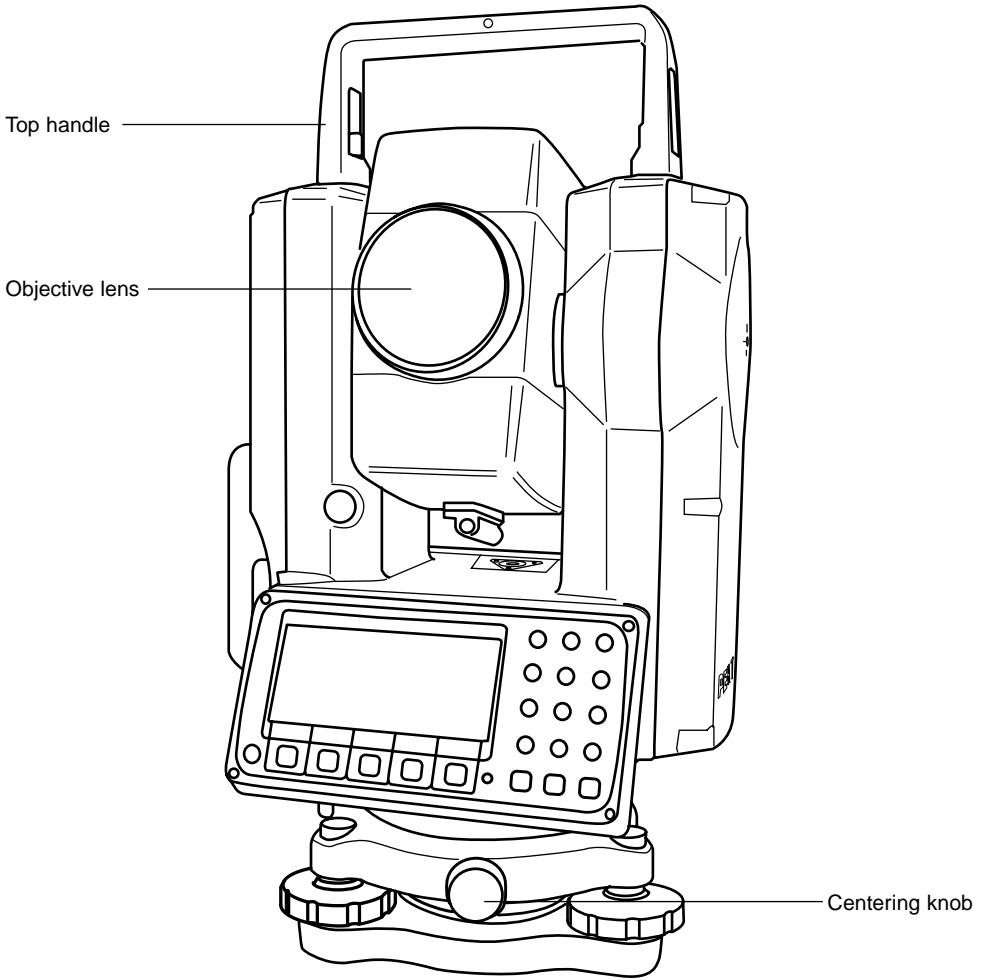

● Dual display panel is an optional accessory.

R-335 (N): Shift type

## 1-2 Unpacking and Packing

### Unpacking the Instrument from the case

- ① Set the case down gently with the lid facing upwards.
- ② Open the latches while pressing down on the lock (safety mechanism) and open the lid of the case.
- ③ Remove the instrument from the case.

### Packing the Instrument in the case

- ① Make sure the telescope is fairly level and lightly tighten the telescope clamp screw.
- ② Line up the housing marks (round yellow marks on the instrument) and tighten the upper and lower clamp screws.
- ③ With the housing marks facing upward, set the instrument gently in the case without forcing it.
- ④ Close the lid to the case and secure the latches.

## 1-3 Standard equipment

- ① Instrument
- ② Carrying case
- ③ BP02 battery
- ④ BC03/AC01 charger
- ⑤ Plumb bob
- ⑥ Hexagonal wrench
- ⑦ Rain cover
- ⑧ Quick Reference Guide (Basic , PTL and PSF procedures)
- ⑨ CD-R (Basic operation & Special Functions manual)

## 1-4 Attaching and Charging the Battery

### Removing the Battery

- ① Turn the lock lever anticlockwise and remove the Battery.
- ② Lift up the battery pack and remove it from the instrument.

- Be absolutely sure to turn the power off when removing the battery as removing the battery while the power is still on may result in damage to the instrument.

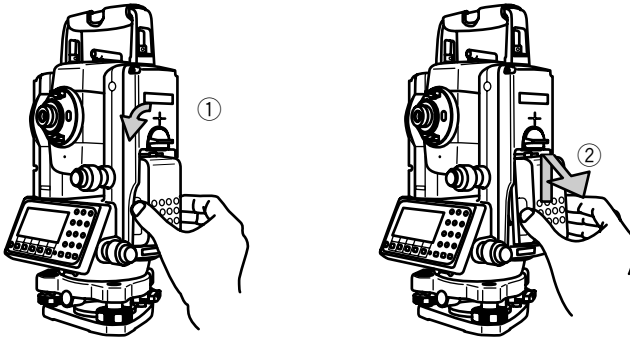

### Attaching the Battery

- ① Align the guide grooves on the battery pack with the guide grooves on the instrument and push the top of the battery pack into place.
- ② Turn the lock lever clockwise to fix.

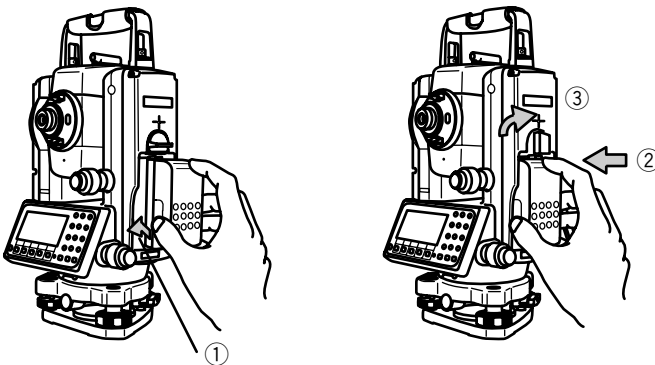

## Remaining Battery Charge

When the instrument's power is turned on, a battery mark “” will be displayed on the right of the display screen. This mark can be used to check the charge status of the battery.

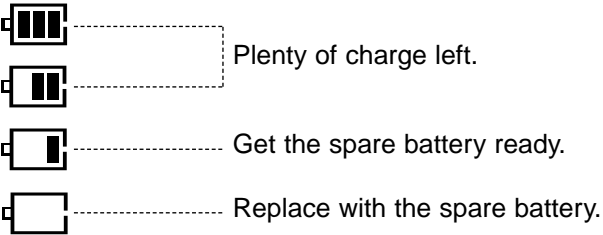

Low battery: Please change. Replace with the spare battery or charge.

## Charging the battery

- The battery BP02 is not charged at our factory shipment so charge it.
- For BP02 charge, use the special BC03 charger.

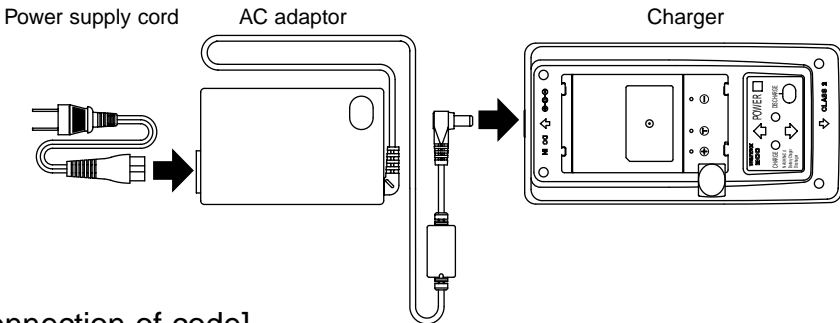

### [Connection of code]

- ① Insert the output plug of the power supply code in Jack of the AC adaptor.
- ② Insert the output plug of the AC adaptor in Jack of the charger.
- ③ Insert the power supply plug of the power supply code in the outlet of AC power supply.

### [Installation of battery]

- ① Draw the battery to the lock lever side and put it on the battery pocket. The battery is firmly installed on the battery pocket.
- ② Press down the battery and then slide it to the opposite direction of the lock lever.
- ③ The lock lever goes up, and the battery is fixed.
- ④ Under such a condition, if “Connection of the code” is done, the charge with the battery is begun.

## 1 BEFORE USING THE INSTRUMENT

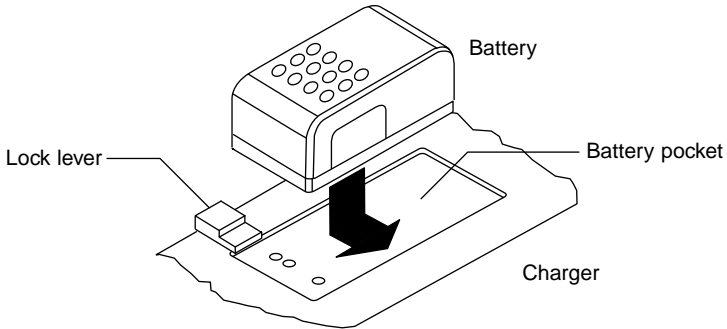

### [Detaching the battery]

- ① Press the lock lever and slide the battery to the lock lever direction.
- ② Detach the battery packing from the battery pocket.

### [Display panel]

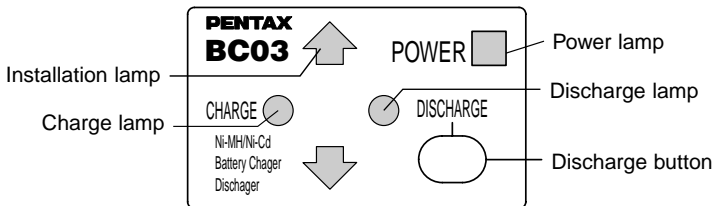

- ① Power supply lamp (red) : Turns on when the power supply is turned on.
- ② Charge lamp (green) : Turns on while charging and turns off when the charge is completed.
- ③ Discharge lamp (yellow) : Turns on when you push the discharge button. Turns off when the discharge is completed.
- ④ Installation lamp (red) : Blinks or turns on when the battery packing is attached normally. Blinks when charge or discharge and turns on when charge is completed. (The charge lamp in the lower does not blink and does not turns on)
- ⑤ Discharge button : Discharge lamp lights when you push this button, and the discharge of battery begins.



## [How to charge]

- ① It begins charging automatically when you set the battery packing in the charger which beams the power supply lamp.
- ② Leave just as it is until the charge is completed.
- ③ When the charge is completed, the charge lamp is turned off.
- ④ Detach the battery packing from the charger when the charge is completed.

## Refreshing the battery

The use time shortens gradually by the phenomenon of “Effect of the memory” when the NiMH battery leaves capacity and repeats the charge. The voltage recovers after refreshing and the use time returns normally in such a battery. Please refresh one degree every five times of the charge.

## [Refreshing]

Set the battery in the charger as well as the case of the charge. Push the electrical discharge button. The electrical discharge lamp lights and the electrical discharge begins.

The electrical discharge lamp is turned off when the electrical discharge ends, the charge lamp lights, and the charge starts automatically. Leave just as it is until the charge is completed. When the charge is completed, the charge lamp is turned off. Detach the battery from the charger.

## [Time of refreshing and charge]

Battery BP02 is discharged from the state of a full charge at about 960 minutes and the charge is completed from the electrical discharge at about 130 minutes. However, the electrical discharge time is proportional to the remainder capacity of the battery. Moreover, the time required for refreshing might be different from the above-mentioned time according to a surrounding temperature and the state of the battery.

# 2 DISPLAY AND KEYBOARD

## 2-1 Display and Keyboard

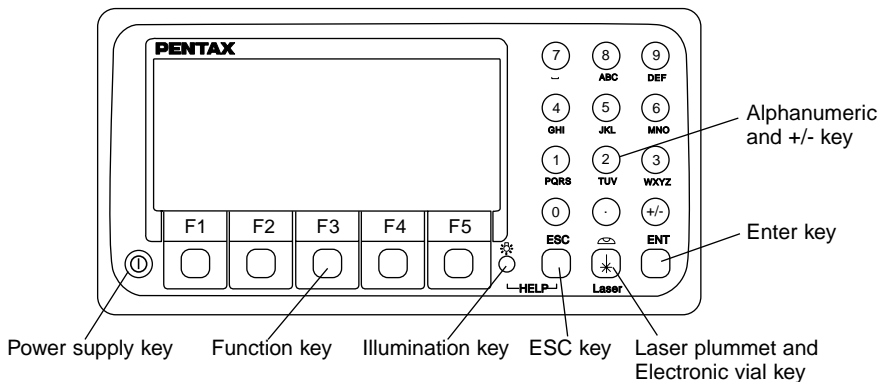

## 2-2 Operation Key

Key	Description
[POWER]	ON/OFF of power supply
[ESC]	Returns to previous screen or cancels an operation.
[Illumination] ☼	Turns the illumination of the LCD display and telescope reticle on and off.
[ENT]	Accepts the selected (highlighted) choice or the displayed screen value.
[Laser]	Displays the laser plummet *1, electronic vial function, and the LD point screen when you push the laser plummet/electronic vial key. (Refer to "2-5 Laser Pointer", "3-2 Laser plummet", and "3-5 Leveling with Electronic vial").
	*1: Only the product with the laser plummet function
[Alphanumeric]	At the numerical value screen, the numerical value and the sign '⌘' displayed are input. The English characters printed right under numeric of each key are input.
[HELP]	Pressing [ILLU]+[ESC] key causes a help menu to appear in A MODE or B MODE or causes a help message to appear.

## 2-3 Function Key

Display	F. Key	Description
<b>Mode A</b>		
[MEAS]	F1	Pressing this key one time measures the distance in normal mode another measurement type can be selected by Initial Setting 2. Pressing this key twice measures the distance in coarse mode another measurement type can be selected by Initial Setting 2.
[TARGET]	F2	Select the target type by following order.  SHEET/ REFRECTORLESS /PRISM (Reflectorless type instrument) SHEET/PRISM (Prism type instrument)
[0 SET]	F3	Resets the horizontal angle to 0° 0' 0" by pressing twice.
[DISP]	F4	Switches the display composition in the order "H.angle/H.dst./V.dst.", "H.angle/V.angle/S.dst." and "H.angle/V.angle/H.dst./S.dst./V.dst.".
[MODE]	F5	Switches the screen between MODE A and MODE B.
<b>Mode B</b>		
[S.FUNC]	F1	PowerTopoLite or PSF
[ANG SET]	F2	Brings up the angle setting screen for setting angle-related parameters (H.ANGLE/%GRADE, H.ANGLE INPUT and R/L REVERSE).
[HOLD]	F3	Pressing this key twice retains (holds) the horizontal angle shown on the display.
[CORR]	F4	Brings up the screen for changing the Target constant, Temperature, Pressure setting.
[MODE]	F5	Switches the screen between MODE A and MODE B.
<b>Other functions</b>		
[←]	F1	Moves the cursor to the left.
[→]	F2	Moves the cursor to the right.
[△]	F1	Goes back five Items on the screen.
[▽]	F2	Goes forward five items on the screen.
[RETICLE]	F3	Changing the Reticle illumination when pressing Illumination key.
[↑]	F3	Moves the cursor up.
[LCD]	F4	Changing the LCD contrast when pressing Illumination key.
[↓]	F4	Moves the cursor down.
[ILLU]	F5	Changing the LCD illumination when pressing Illumination key.
[CLEAR]	F5	Clear the figure.
[SELECT]	F5	Open the selection window.

## 2 DISPLAY AND KEYBOARD

[How to move the menu number]

Example:

The cursor is located at Menu 1.

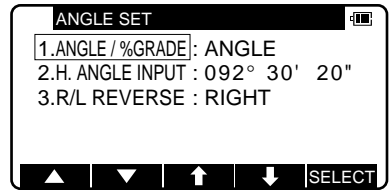

Press the numeric key 0 and 2 to move to Menu 2 or press [F4] [↓].

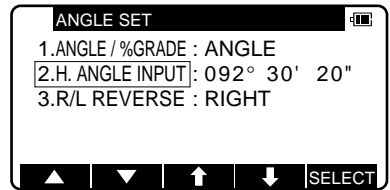

## 2-4 Alphanumeric Input

The point name is inputted by the Alphanumeric keys as following.

Key	Letter under Key	Letter & Figure order to input
[0]		[@][.][_][-][:][/] [0]
[1]	PQRS	[P][Q][R][S][p][q][r][s][1]
[2]	TUV	[T][U][V][t][u][v][2]
[3]	WXYZ	[W][X][Y][Z][w][x][y][z][3]
[4]	GHI	[G][H][I][g][h][i][4]
[5]	JKL	[J][K][L][j][k][l][5]
[6]	MNO	[M][N][O][m][n][o][6]
[7]		[ ] [?] [!] [ _ ] [ ^ ] [ ] [ & ] [ 7 ]
[8]	ABC	[A][B][C][a][b][c][8]
[9]	DEF	[D][E][F][d][e][f][9]
[.]		[.][.][.][.][#][()]
[+/-]		[+][-][*][/][%][=][<][>]

## 2-5 LD POINT, Laser Pointer

The Laser pointer function turns the laser beam on continuously to become the aiming point so that visual confirmation is possible.

- ① When the [LD POINT] key is pressed after pressing the [Laser] key, the Laser pointer function is turned on. The Laser indicator is turned on and the “” mark on the left of the screen blinks while the Laser pointer function is operating.
  - ② If the [Laser] key is pressed and the [LD POINT] key is pressed while the Laser pointer function is operating, the Laser pointer function is turned off.
- The beam of the sun is strong and visual confirmation is difficult in daytime when outdoors.
  - The laser beam is designed not to be able to observe through the telescope.
  - Please visually align the laser beam to the target and mark the center. Confirm the alignment (horizontal and vertical ) before measuring when performing accurate work like stake out when using the Laser pointer function. Also refer to 10-10. The EDM beam axis.
  - Please do not look at the laser source of beam directly.

# 3 PREPARATION FOR SURVEYING

## 3-1 Centering and Leveling of the Instrument

### Setting up the instrument and the tripod

- ① Adjust the tripod legs so that a height suitable for observation is obtained when the instrument is set on the tripod.
- ② Hang the plumb bob on the hook of the tripod, and coarse center over the station on the ground. At this time, set the tripod and fix the metal shoes firmly into the ground so that the tripod head is as level as possible, and the plumb bob coincides with the station on the ground.
- ③ If the tripod head is mis-leveled by the action of fixing the metal shoes into the ground, correct the level by extending or retracting each leg of the tripod.

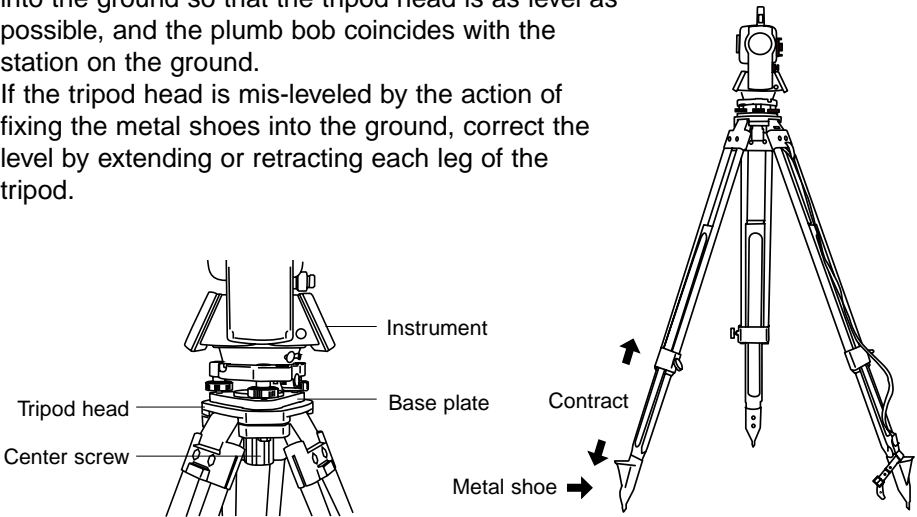

## 3-2 Laser plummet

### Laser plummet model

The laser plummet is not set to be ON at factory shipping. The laser plummet operation of power supply ON can be set by command No 520, LD PLUM & E VIAL. For using Command number, refer to 9-2. Accessing by 007.

#### [For the Detaching type laser plummet equipment model]

Turn on the laser plummet function by pushing the Laser key.

Match the position with the leveling screw so that the laser mark coincides with the ground mark.

- The laser plummet is emitted only when 1.LD PLUM. ON of Command No. 520 is selected and the Electronic vial screen is displayed. The screen is used as the “Laser emission indicator” of the Laser plummet.

### [For the Shift type laser plummet equipment model]

- Turn on the laser plummet function by pushing the Laser key.
- Match the position by the tripod so that the laser mark coincides with the ground mark.
- The centering knob is loosened, and the upper plate is pushed by the tip of a finger, and a center mark is matched to the ground mark.
- Tighten the centering knob.
- Loosen the horizontal clamp screw, and rotate the instrument by 90°, and confirm the vial of the circular vial is at the center at any position.  
Correct the vial with the leveling screw when the vial comes off from the center.

### [Brightness adjustment of laser]

Sometimes the state of the surface of the ground mark or a surrounding environmental dose not allow observing the laser spot easily. Please adjust the brightness of the laser if necessary.

If the Laser key is pressed, the brightness adjustment screen of the laser plummet device, is displayed.

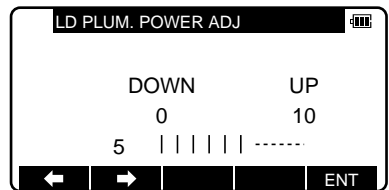

The Laser plummet becomes dark by ← key and becomes bright by → key

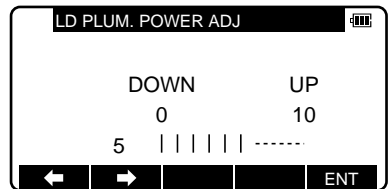

The adjustment is completed with the ENT key and it returns to electronic vial screen.

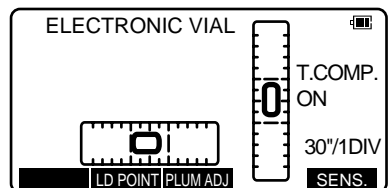

### 3 PREPARATION FOR SURVEYING

- The brightness adjustment step of the laser is 10 steps.
- The laser plummet spot can become difficult to see in bright sunlight which makes it difficult to perform the occasional check. In this case, use your foot or the carrying case to make a shadow over the laser position.
- The laser plummet is adjusted to be within  $\pm 0.8$  mm at the instrument height of 1.5m at factory shipping.
- Please confirm the amount of the gap (direction of X and Y direction) with the laser plummet beforehand compared with plumb bomb etc. when working like accurately putting out a perpendicular direction using the laser plummet function.
- Please do not look at the laser source of beam directly.

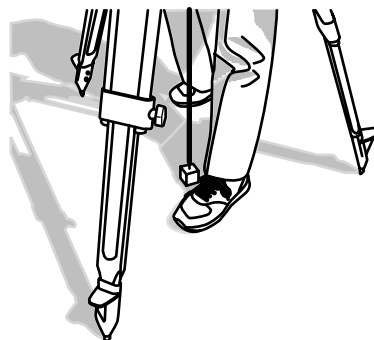

## 3-3 Optical plummet (Option)

### [Detachable type]

- ① Look through the optical plummet eyepiece, and rotate the eyepiece knob until the center mark can be seen clearly.
- ② Rotate the focusing knob of the optical plummet and adjust the focus to the station on the ground.
- ③ Rotate the levelling screws and align the center mark to the ground mark.

### [Shift type]

- ① Look through the optical plummet eyepiece, and rotate the eyepiece knob until the center mark can be seen clearly.
- ② Rotate the focusing knob of the optical plummet and adjust the focus on the ground mark.
- ③ Loosen the centering clamp screw and push the upper plate by finger and stay the center mark on the ground mark.
- ④ Tighten the centering clamp screw.
- ⑤ Loosen the horizontal clamp screw and rotate the instrument every  $90^\circ$  and confirm the Circular vial is centered correctly. If the bubble is not centered, it can be properly set using the leveling screws.



### 3-4 Leveling with Circular vial

Tripod is adjusted according to the following points by extending or contracting the legs so that the bubble of the Circular vial goes to the center of the circle.

- Shorten the leg at the side of the bubble or extend the leg opposite of the bubble to position the bubble in the center of the vial circle.
- All three legs are extended or contracted until the bubble is in the center. During this process, the foot is not placed on the tripod leg point and the position of the tripod points do not change.

### 3-5 Leveling with Electronic vial

#### [Electronic vial screen]

1. If the Laser key is pushed, it becomes a display screen for the Electronic vial.

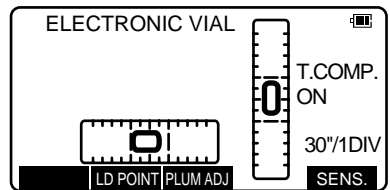

2. It returns to the former screen by the [ESC] key.

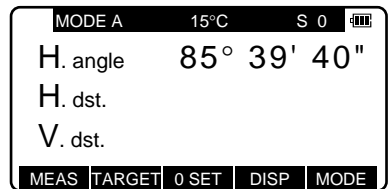

- When R-300 instrument is seen at the position of “Left circle position”, the screen in the electronic vial shows the correct movement direction. Please note that the movement of the electronic vial is in the opposite direction when the observing in “Right circle position”.
- When instrument is within the tilt compensation range, length and sidewise $\pm 3'$ , “ON” is displayed at the right screen, “OVER” is displayed beyond the limits of range and “NIL” is displayed at no compensation setting.
- With command No “520” or “Initial setting 2”, when the [TILT DISP] is selected as ON, the [F1-TILT] of the vial screen becomes effective. The Vial tilt value is indicated when pushing the [TILT] key. With “TILT DISP.UNIT” of the Initial setting 2, OFF or ON can be selected.

**[Leveling]**

- ① Rotate instrument horizontally and make two Leveling screws arbitrarily chosen parallel to the display.
- ② Turn on the Electronic vial function by pushing the Laser key.  
Put the bubble of the Circular vial in the center of the circle when the display shows "TILT OVER".
- ③ Turn two Leveling screws arbitrarily chosen in an opposite direction mutually and put the vial of the horizontal Electronic vial in the center. (Figure A)
- ④ Put the bubble of the lengthwise Electronic vial in the center by operating the Leveling screw of one remainder. (Figure B)
- ⑤ The procedures are different according to the state of the Automatic inclination correction as following.

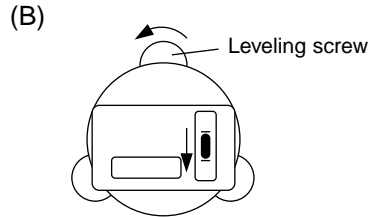
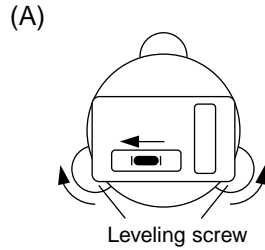

**[When using the Automatic inclination correction by 2 axes]**

Please read procedure ⑥ because the horizontal angle and the perpendicular angle error by a perpendicular axis are automatically corrected.

**[When using the Automatic inclination correction by 1 axis]**

The instrument is horizontally rotated by 180° after the bubble of the Electronic vial is adjusted on the center at a Left circle position side and confirm that the bubble of the vial is at the center at the right circle position.

**[When using without Automatic inclination correction]**

Confirm the bubble is at the center even if the instrument is rotated by each 90°.

- ⑥ Confirm whether the plummet is on the ground mark. When you confirm it is not on the mark, loosen the center screw and move the instrument over the ground mark correctly and fix the instrument by a center screw. Repeat from ① to ⑥.

## 3-6 Eyepiece Adjustment

### Eyepiece adjustment

The eyepiece adjustment is performed before target sighting.

- ① Remove the telescope lens cap.
  - ② Point the telescope at a bright object, and rotate the eyepiece ring full counter-clockwise.
  - ③ Look through the eyepiece, and rotate the eyepiece ring clockwise until the reticle appears as its maximum sharpness.
- When looking into the eyepiece, avoid an intense look to prevent parallax and eye fatigue.
  - When it is hard to see the reticle due to poor brightness, press [ILLU] to illuminate it . For adjusting intensity of brightness, refer to page 35.

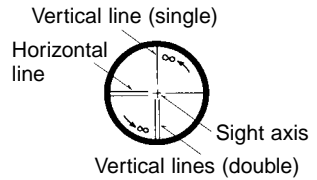

## 3-7 Target Sighting

### [Auto focus]

The Auto focus mechanism is very precise but will not function under every condition. There is a slight possibility of focusing failure owing to brightness, contrast, the shape and size of the target.

In such a case, press the AF button and focus on the target by operating the Power focus key or the AF ring.

<Target examples which are hard to focus>

No contrast like a white wall

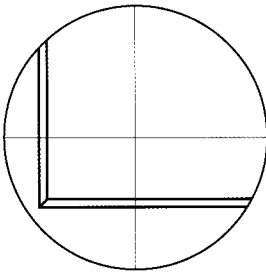

Bright back light

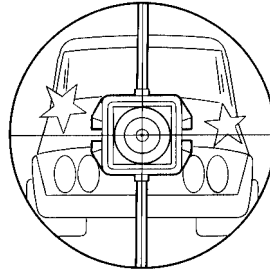

Obstacle in front of a target

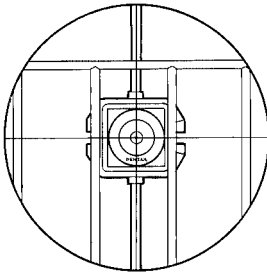

A wall composed of single horizontal lines

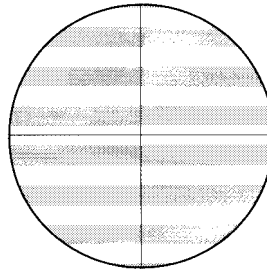

### [Target sighting by Auto focus]

The Auto focus of R-300 series has following two modes.

1. Normal mode : Pressing AF button focuses on the target.
2. Continuous mode : Pressing AF buttons for two seconds beeps, and releasing the key enters into the Continuous mode. This mode enables you to perform the Auto focus approx. for one minutes only by sighting through the telescope and following the target.

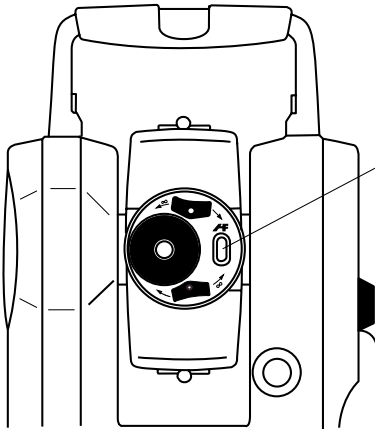

- Normal mode : Press the AF button.  
Continuous mode : Pressing AF buttons for two seconds beeps and release the key.

**[Auto focus :Target sighting by Normal mode]**

- ① Loosen the telescope clamp and horizontal clamp screws.
- ② Point the telescope at the target using a collimator.
- ③ Tighten the above two screws.
- ④ Adjust the eyepiece.
- ⑤ Look through the telescope and press the AF button. Move your eye vertically and horizontally to see if the target image moves in relation to reticle.
- ⑥ Align the reticle accurately on the target using telescope and horizontal tangent screws.

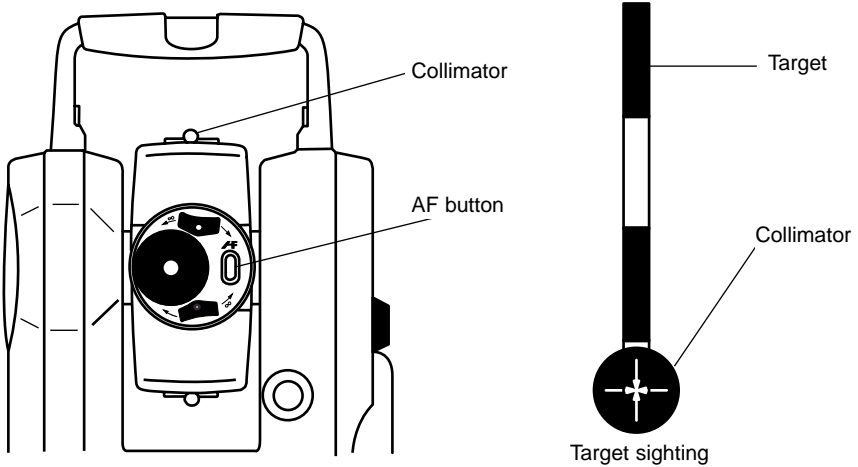

- If the target image does not move, there is no parallax. If it moves, eliminate the parallax.
- Even when vertical angle measurement is not performed, it is recommended that the target should be placed at the reticle center.
- Operating the Power focus key rotates the AF ring, so do not touch it while it is rotating.

### [Auto focus :Target sighting by Continuous mode]

- ① Loosen the telescope clamp and horizontal clamp screws.
- ② Point the telescope at the target using a collimator.
- ③ Tighten the above two screws.
- ④ Adjust the eyepiece.
- ⑤ Look through the telescope and then press the AF button for two seconds to beep, and release the key to enter into the Continuous mode.
- ⑥ Align the reticle accurately on the target using telescope and horizontal tangent screws.
- ⑦ Point the telescope to the next target as well.

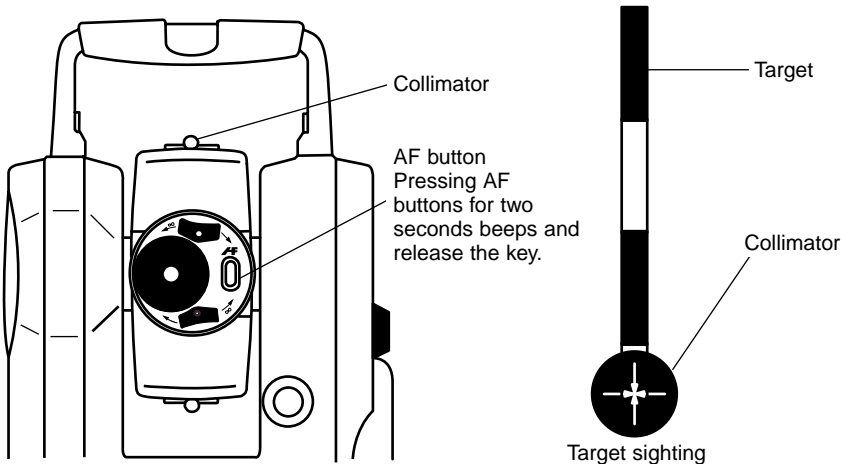

- Keep the target close to the reticle center when following it by the Continuous mode.
- Continuous mode automatically ceases after approx. one minute.
- Pressing the AF button or operating the Power focus key releases the continuous mode.
- Operating the Power focus key rotates the AF ring, so do not touch it while it is rotating.

### [Auto focus :Target sighting by Power focus mode]

- ① Loosen the telescope clamp and horizontal clamp screws.
- ② Point the telescope at the target using a collimator.
- ③ Tighten the above two screws.
- ④ Adjust the eyepiece.
- ⑤ Look through the telescope, and then operate the Power focus key and focus on the target.
- ⑥ Align the reticle accurately on the target using telescope and horizontal tangent screws.

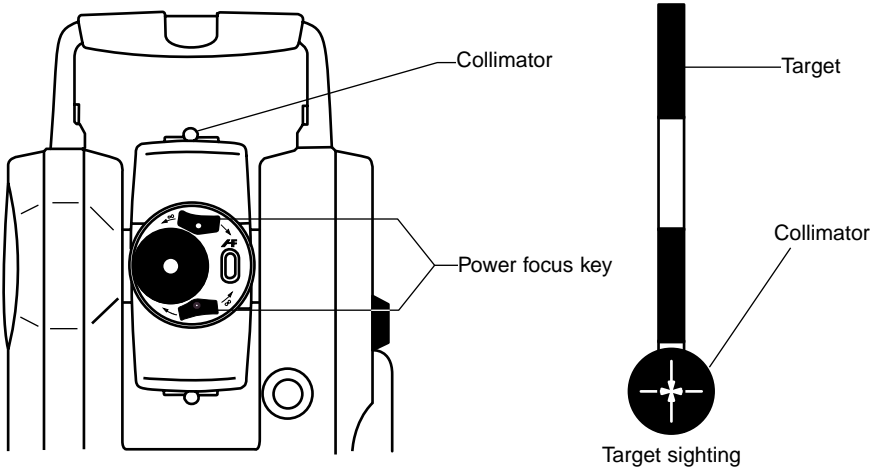

- Tilting the Power focus key “clockwise” makes it possible to focus on closer objects and “counterclockwise” will focus on farther objects.
- Tilting angle of the Power focus key makes it possible to perform following three focusing speeds.
  - Low speed : When tilted to middle position by approx. 5 degrees
  - Middle speed : When tilted fully by approx. 10 degrees
  - High speed : When tilted fully by approx. 10 degrees and passed one second
- Operating the Power focus key rotates the AF ring, so do not touch it while it is rotating.



**[Target sighting by Manual focus]**

- ① Loosen the telescope clamp and horizontal clamp screws.
- ② Point the telescope at the target using a collimator.
- ③ Tighten the above two screws.
- ④ Adjust the eyepiece.
- ⑤ Look through the telescope and then rotate the Focusing knob and stop it where the target can be seen clearly and the target image does not move in relation to reticle even if your eye is vertically and horizontally moved.
- ⑥ Align the reticle accurately on the target using telescope and horizontal tangent screws.

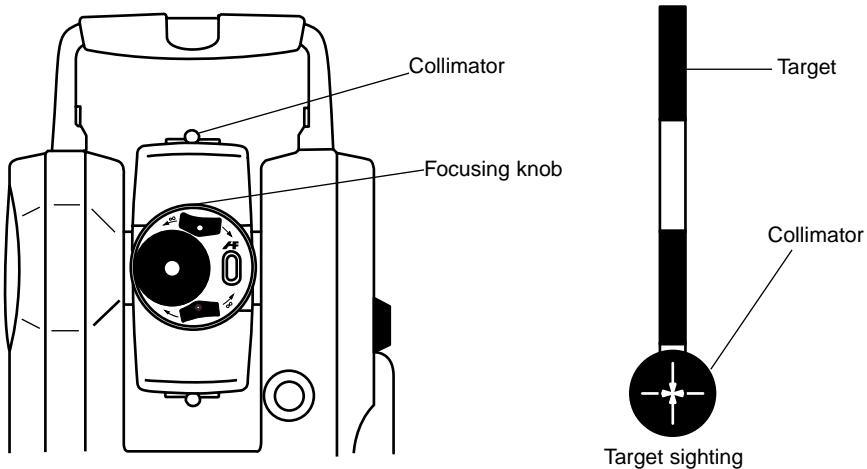

- The Focusing knob rotation “clockwise” makes it possible to focus on closer objects and “counterclockwise” will focus on further objects.
- The target sighting by manual focus of R-362 can be performed by the above same procedures.

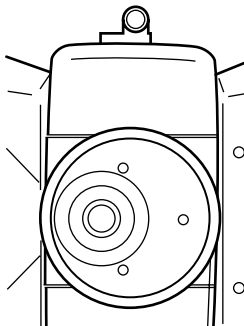

Eyepiece section of R-326.

### 3-8 Attachment and Detachment of Tribrach

The tribrach of R-322, 323, 325, 322N, 323N, 325N, and 326 are detachable from the instrument if required when replacing the instrument with a target or unit prism for example.

#### Detachment

First loosen the recessed screw with a screwdriver, then rotate the locking knob until the arrow points upward, and lift the instrument up.

#### Attachment

Mount the instrument on the tribrach with the guide marks coinciding, and rotate the locking knob until the arrow points downward.

The guide and guide mark must be fitted to attach the instrument. When the tribrach does not need to be attached or detached or instrument is to be transported, tighten the recessed screw with a screwdriver to fix the locking knob.

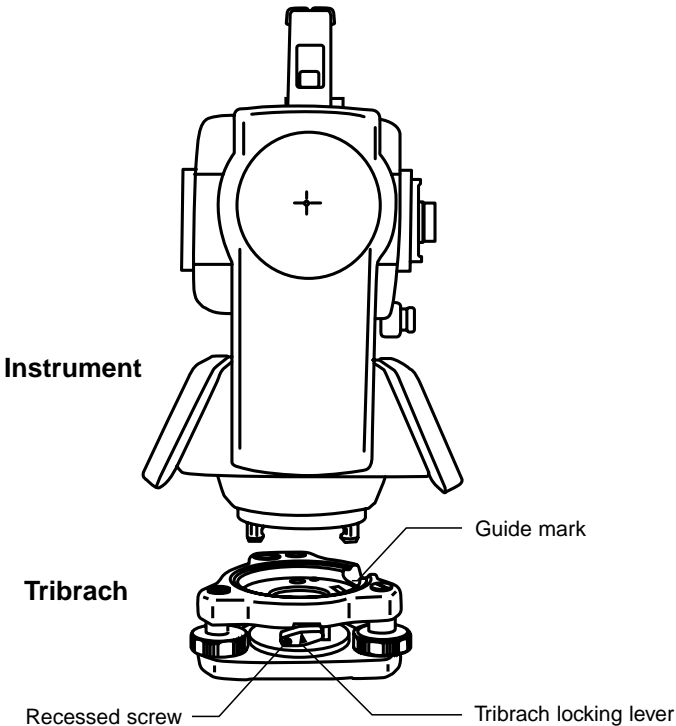

# 4 TURNING THE POWER ON

## 4-1 Turning the Power On and Off

Pressing the [POWER] key shows the initial screen.

(The [POWER] key is also used to turn the power off.)

After a few seconds, it turns to Electronic vial screen. Move the bubbles to center by adjusting the leveling screws.

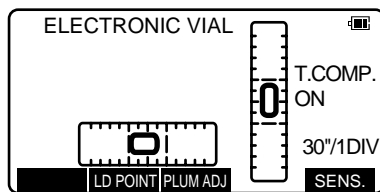

Pressing the [ENT] key views the angle and distance measurement screen.

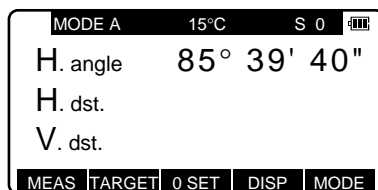

- The Auto Power Off function will automatically turn the power off if no operations are performed for approximately 10 minutes. (Factory default setting)
- The [POWER] key is controlled by software in the instrument while it is working, and this key is valid only when turning off causes no problem.
- The value displayed when the power was last time turned off will be displayed for the horizontal angle. If this horizontal angle is not needed, please perform horizontal angle 0 SET.

For details on resetting the horizontal angle 0 .....See page 37.

For details on changing the horizontal angle from

clockwise to counterclockwise .....See page 41.

For details on measuring the vertical angle .....See page 40.

For details on distance measurement .....See page 42.

For details on the automatic power-off function .....See page 59.

For details on the Electronic vial .....See page 65.

## 4-2 Adjusting LCD Contrast

Press [F4] while holding down the Illumination key to access the screen for adjusting LCD contrast.

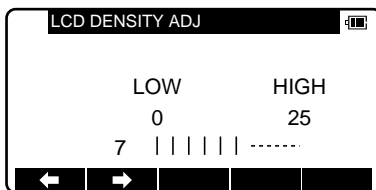

Pressing [F1] [↵] will lighten the contrast, while pressing the [F2] [⇨] will darken the contrast.

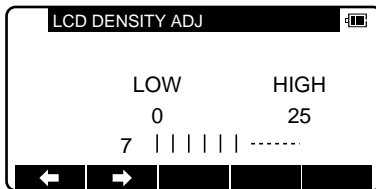

Press [ENT] to exit adjustment mode and return to the previous screen.

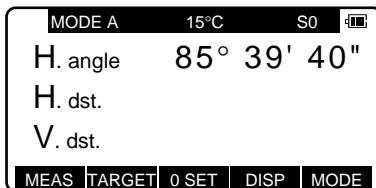

- Pressing the Illumination key views the F3-RETICLE, F4-LCD and F5-ILLU.
- LCD contrast may be adjusted as necessary at any time.
- The contrast may be adjusted to any one of 25 levels.
- LCD contrast may be unappealing under certain environmental conditions such as high temperature. Adjust the LCD contrast as described above in such situations.

### 4-3 Adjusting Illumination Brightness

Press [F5] while holding down the Illumination key to access the screen for adjusting illumination brightness.

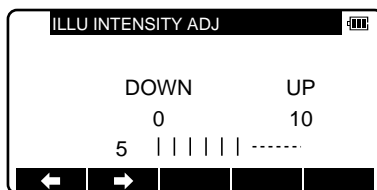

Pressing the [F1] [←] will decrease brightness, while pressing the [F2] [→] will increase brightness.

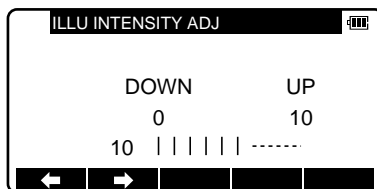

Press [ENT] to exit adjustment mode and return to the previous screen.

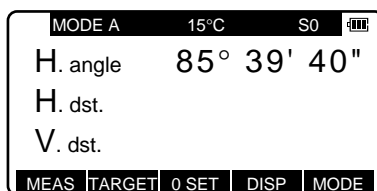

- Pressing the Illumination key views the [F3] [RETICLE], [F4] [LCD] and [F5] [ILLU].
- Illumination brightness of the LCD screen and telescope reticle may be adjusted as necessary at any time.
- Illumination brightness may be adjusted to any one of 10 levels.

### 4-4 Adjusting Reticle Illumination

Press [F3] while holding down the Illumination key to access the screen for adjusting reticle illumination. The procedure to adjust the reticle illumination is the same way as 4-3.

- Pressing the Illumination key views the [F3] [RETICLE], [F4] [LCD] and [F5] [ILLU].

# 5 ANGLE MEASUREMENT

## 5-1 Measuring an Angle

Aim at the first target, then press [F3] [0 SET] twice in succession to reset the horizontal angle to 0.

MODE A	15°C	S0	
H. angle	0° 00' 00"		
H. dst.			
V. dst.			
MEAS	TARGET	0 SET	DISP   MODE

Aim at the second target, then read the horizontal angle.

MODE A	15°C	S0	
H. angle	60° 30' 20"		
H. dst.			
V. dst.			
MEAS	TARGET	0 SET	DISP   MODE

Pressing [F4] [DISP] displays the vertical angle.

MODE A	15°C	S0	
H. angle	60° 30' 20"		
V. angle	87° 05' 40"		
S. dst.			
MEAS	TARGET	0 SET	DISP   MODE

- The [0 SET] key cannot reset the vertical angle to 0.
- Pressing the [DISP] key cycles through the sets of display items: "H.angle/H.dst./V. dst.", "H angle/V.angle/S.dst.", and "H.angle/V. angle/H.dst./S.dst./V.dst."
- Even though you turn the power off during a survey, the horizontal angle displayed last time is saved, so that it is restored when the power is turned on next time.
- When the restored horizontal angle is not necessary, reset it to 0.

## 5-2 Resetting the Horizontal Angle to 0

Pressing [F3] [0 SET] twice in succession resets the horizontal angle to 0° 0' 0".



- The [F3] [0 SET] cannot reset the vertical angle to 0.
- Pressing the [F3] [0 SET] accidentally during measurement does not reset the horizontal angle to 0 unless you press it again. Once the buzzer stops sounding, you can go to the next step.
- You can reset the horizontal angle to 0 any time except when it has been held.

## 5-3 Holding the Horizontal Angle

To hold the horizontal angle currently being displayed, press [F3] [HOLD] twice in succession.

The horizontal angle value is displayed in reverse video when being held.

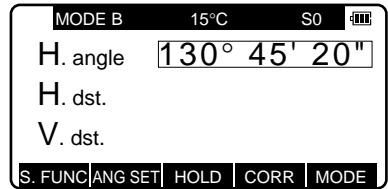

- If you want to hold the horizontal angle when you are in mode A, press [F5] [MODE] first to switch to mode B, then press [F3] [HOLD].
- The [F3] [HOLD] cannot hold the vertical angle or distance.
- To release the horizontal angle from being held, press [F3] [HOLD] once.
- Pressing [F3] [HOLD] accidentally during measurement does not hold the horizontal angle unless you press it again. Once the buzzer stops sounding you can go to the next step.

## 5-4 Inputting an Arbitrary Horizontal Angle

In case of Horizontal angle 123° 45' 20" input

Press [F5] [MODE] to enter mode B.

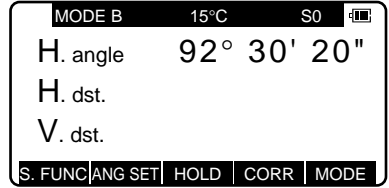

Press [F2] [ANG SET] to display the angle setting screen, then press [F4] [↓] to move the cursor to "2. H. ANGLE INPUT".

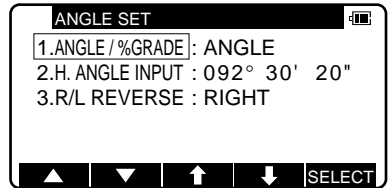
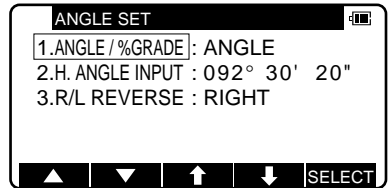

Press [F5] [SELECT] to open the horizontal angle input window.

[F5] [CLEAR] is used to clear the values.

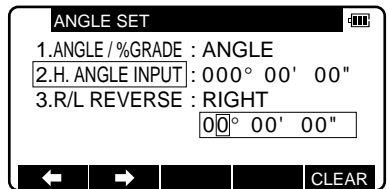
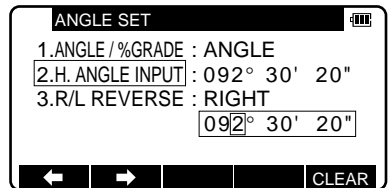



Press the numeric key as 123.4520.

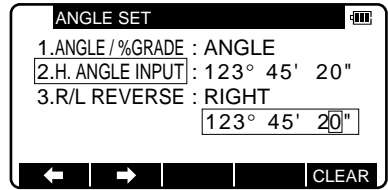

Press the [ENT] key to accept the horizontal angle set to 123° 45' 20" and change the screen to mode A.



- The former data is called by pressing the [CLEAR] key again.

## 5-5 Displaying the % Slope of the Vertical Angle

Press [F5] [MODE] to enter mode B.

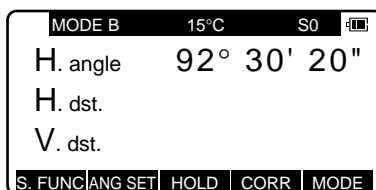

Press [F2] [ANG SET] to display the Angle setting screen.

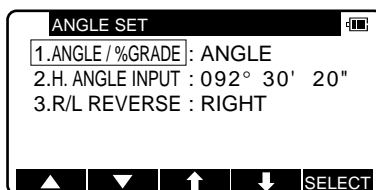

Press the [F5] [SELECT] to change the screen to display the slope % of Vertical angle.

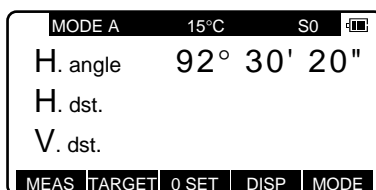

Press [F4] [DISP] to display the slope value in %.

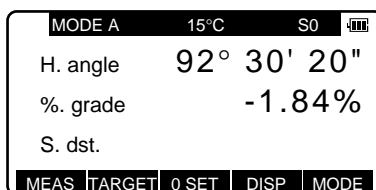

- The 0% represents the horizontal 0, and +100% and -100% represent 45° up and down slopes respectively.
- To return the screen from the slope (%) display to the 360° scale, also take above same steps by entering mode B.
- If the slope (%) exceeds [+/-]1000%, “Out of grade range” is displayed, indicating that the current vertical angle cannot be measured.
- When the telescope returns to a slope within slope [+/-] 1000%, the slope (%) display returns automatically from the “Out of grade range” message to the numeric value.

## 5-6 Changing the Horizontal Angle from Clockwise to Counterclockwise

Press [F5] [MODE] to enter mode B.

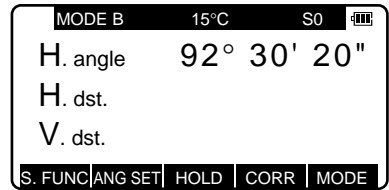

Press [F2] [ANG SET] to display the Angle setting screen.

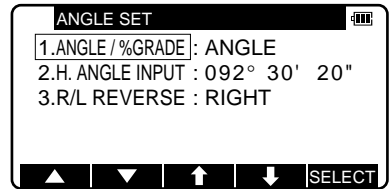

Press [F4] [↵] to move the cursor to "3. R/L REVERSE".

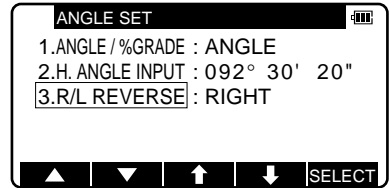

Press [F5] [SELECT] to add a minus sign (-) to the horizontal angle value as a counterclockwise angle.



- To return the horizontal angle from counterclockwise to clockwise, also take the above same procedures, press [F5] [SELECT] to select the clockwise angle.
- When the counterclockwise horizontal angle is selected, the order of aiming at the targets becomes the reverse (the right one first, then the left one) of the order for the clockwise angle.

# 6 DISTANCE MEASUREMENT

## 6-1 Target Setting

The target mode and its Constant of current setting are shown at the left of the battery mark. For example in case of each Constant 0, Reflector sheet; S 0, Reflectorless(Non-Prism); N 0, Prism; P 0

Pressing [F2][TARGET] changes the target mode.

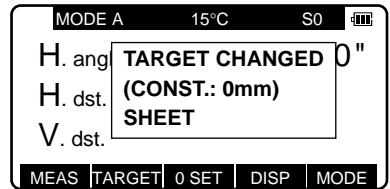

- The target mode is changed sequentially as follows.  
Reflector sheet - Prism - Reflectorless (reflectorless models), Reflector sheet - Prism (standard models).
- The selected target mode is stored in the memory even if the power is turned off. So, next time you can use the same mode after turning on.
- The target Constant differs according to the selected target mode.  
So, confirm the target mode and its Constant shown at the top screen after changing the target.

### 1. (Distance measurement by Reflectorless (Non-Prism) mode)

- The measurement range is determined by the white side of the Kodak Gray Card facing the instrument and by its surrounding brightness.  
There is a possibility that the range may vary when the target does not satisfy the conditions above at survey work.
- Pay attention to the following in case of distance measurement by Reflectorless. In case of resulting in low accuracy, perform the distance measurement by Reflector sheet or Prism.
- The Reflectorless "Long Range mode" can be accessed by the 007 CODE number 521 [REF.LESS RANGE]. The measurement range of this mode is 150m and the Laser class is IIIa. This mode can be performed by selecting the "LONG" at 1.REF.LESS RANGE.
- The CODE number 521 [REF.LESS RANGE] shows 1.REF.LESS RANGE (NORMAL/LONG), 2.LONG RANGE MES(ON/OFF), and 3.LONG RANGE SETUP(EACH TIME/PERMANENT).
- The WARNING (Laser Power) screen is displayed when Range LONG and Message ON are selected, and then [F1] [MEAS] key is pressed. [F1] [MEAS], [F3] [NORMAL] and [F5] [LONG] are viewed.
- Pressing [MEAS] one time selects "Second MEAS setting" and twice selects "QUIT". And then, Normal or Long measurement is selected by pressing F3 or F5.

- ① There is a possibility that correct distance measurement may be impossible by dispersion or reduction of laser beam when the laser beam comes into the target from diagonal angle.
- ② There is a possibility that the instrument cannot calculate correctly when receiving reflected laser beam from forth and back directions in case of measuring the target on the road.
- ③ There is a possibility that synthesized values are calculated and the distance may become longer or shorter than the actual one when the operator measures the target of slope or sphere or rugged shape.
- ④ There is a possibility that the instrument cannot calculate correctly collecting the reflected laser beam from a man or a car that comes and goes in front of the target.

## **2. Distance measurement by Reflector sheet mode**

Position the Reflector sheet whose reflecting surface faces the aiming line to be approx. right angle when the distance is measured by it. If it is positioned not to be approx. right angle, there is a possibility that correct distance measurement may be impossible by dispersion or reduction of laser beam.

## **3. Applied measurement range by Each target mode**

- (Reflectorless (Non-Prism) mode):  
It can measure the distance by Reflector sheet and Prism, but the measurable distance is less than 200m.
- Reflector sheet mode:  
It can measure the distance by Prism mode, but the measurable distance is less than 1000m.
- Prism mode:  
It can measure by Reflector sheet as well.
- Reflector sheet mode and Prism mode:  
It is sometimes possible to measure without reflector sheet or prism under special conditions like in the close distance, targeting on a wall surface. However, there is a possibility including some errors in this case, so be sure to select the Reflectorless mode.
- The target Constant should be correctly selected and confirmed in case that the Reflector sheet is used at the Prism mode and the Prism is used at the Reflector sheet mode.

## 6-2 Distance Measurement

The R-300 series has two distance measurement modes of primary MEAS and second MEAS. Pressing the [F1][MEAS] one time goes to MEAS and twice goes to second MEAS.

You can freely select and allocate your desired measurement mode in primary MEAS and second MEAS by the Initial Setting 2. The “MEASURE SHOT” is set at primary MEAS and “TRACK CONT” is set at second MEAS as a Factory default setting.

- MEASURE SHOT means the Distance measurement by the Shot mode.
- MEASURE CONT means the Distance measurement by the Continuous mode.
- TRACK SHOT means the Fast distance measurement by the Shot mode.
- TRACK CONT means the Fast distance measurement by the Continuous mode.

Confirm the target Constant before beginning the distance measurement.

### Example: “MEASURE SHOT” at primary MEAS (Factory default setting)

Collimate the telescope at a Target and press the [F1] [MEAS] once to start measuring the distance.

Once distance measurement has been started, the distance measurement mark remains displayed.

Upon reception of a reflected light from the Target, the instrument beeps and displays the

\* mark to start the Shot measurement automatically.

- If the instrument is in mode B, press the [F5][MODE] to switch to mode A and press [F1] [MEAS].
- Pressing the [F1][MEAS] after collimating the telescope at the prism starts Shot distance measurement with the “MEAS” text blinking. Distance measurement is completed and the “MEAS” text stops blinking the moment the distance measured by Shot measurement is displayed. During Continuous measurement, the “MEAS” text keeps on blinking. Pressing the [F1][MEAS] again terminates both distance measurement and blinking the “MEAS” text.
- Pressing [F4] [DISP] cycles through the sets of display items: “H.angle/H.dst./V.dst.”, “H.angle/V.angle/S.dst.”, and “H.angle/V.angle/H.dst./S.dst./V.dst.”
- Pressing the [ESC] or [F2][TARGET] or [F5][MODE] during distance measurement stops it.

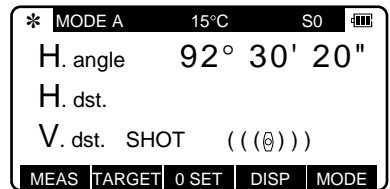

- If the shot count for distance measurement has been set to 2 or more in “Initial Setting 2”, the distance is measured for the specified number of times to display the averaged value.
- If the Automatic Distance measurement : [AUTO MEAS] in “Initial Setting 2” has been set to “MEAS” the first measurement is started only by aiming at the Target. Press [F1] [MEAS] for each measurement after the first one.
- If the Automatic Distance Signal : [MEAS SIGNAL] in “Initial Setting 2” has been set to VALUE, a two-digit number representing the AIM value appears as soon as measurement starts (The AIM value varies depending on the distance and atmospheric conditions.)
- The minimum distance unit : [MEAN. MIN DISP] COARSE or FINE can be selected by the initial setting 2.

### Example: “TRACK CONT” at second MEAS (Factory default setting)

Collimate the telescope at a Target and press [F1] [MEAS] twice in succession to start measuring the distance, Upon reception of a reflected light from the Target, the instrument beeps and displays the ✱ mark to start the TRACK distance measurement.

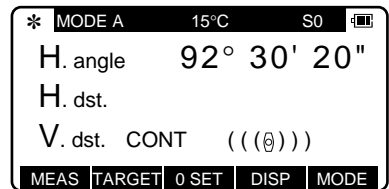

- If the instrument is in mode B, press [F5] [MODE] to switch to mode A and press [F1] [ MEAS ] twice.
- Pressing [F1] [MEAS] twice after collimating the telescope at the Target starts Continuous distance measurement at fast speed with the “MEAS” text blinking. It remains blinking during the measurement. If you press the [F1] [ MEAS ] again, Distance measurement is completed and the “MEAS” text stops blinking.
- Pressing [F4] [DISP] cycles through the sets of display items: “H.angle/H.dst./V.dst.”, “H.angle/V.angle/S.dst.”, and “H.angle/V.angle/H.dst./S.dst./V.dst.”
- Pressing the [ESC] or [F2] [TARGET] or [F5] [MODE] during fast distance measurement stops it.

# 7 CORRECTION MODE

## 7-1 Changing the Target Constant

Changing the Target Constant can be performed only when the Reflector sheet and Prism Constant settings are "INPUT" in Initial Setting 1.

Example: Prism Constant - 25mm setting

Press [F4] [CORR] in mode B.  
 (If the instrument is in mode A, press [F5] [MODE] to enter mode B.)  
 (SHEET CONST : Reflector sheet constant)

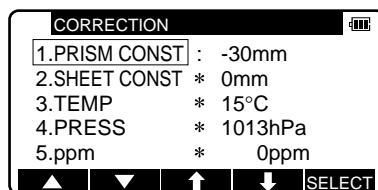

Press the [F5] [SELECT] to enable the Prism Constant to be changed.

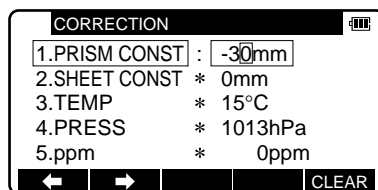

Clear the exiting values by pressing [CLEAR] key.  
 Input 25 by pressing the numeric keys.



Press the [ENT] key to accept the Prism Constant to -25 mm.

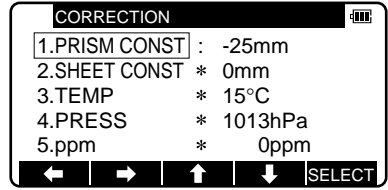

Pressing the [ENT] key returns the instrument to mode A.

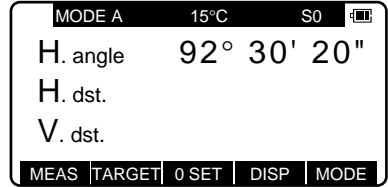

- To set the Reflector sheet constant to “0” select “0” for “Prism Constant” in “Initial Setting 1”.
- To set the Prism constant to “0” or “- 30” select “0” or “- 30” for “Prism Constant” in “Initial Setting 1”.
- When the “Reflector sheet Constant” has been set to “0” in Initial Setting 1 and “Prism Constant” has been set to “0” or “- 30”, “\*” is displayed to the left of “0” or “- 30” on the correction menu screen. When “\*” is on the screen, the Constant cannot be changed (by entering a numeric key).
- Once set, the Reflector sheet Constant and Prism Constant remains on the measurement screen as “S 0” or “P 0”.
- The factory initial of Reflector sheet Constant and Prism Constant are 0.
- Once set, each Constant remains in memory even after the power is turned off.

## 7-2 Changing the Temperature

The temperature setting can be changed only when “Atmospheric Correction” has been set to “ATM INPUT” in “Initial Setting 1”.

Example: Setting the temperature to +22°C

Press [F4] [CORR] in mode B.  
 (If the instrument is in mode A, press [F5] [MODE] to enter mode B.)

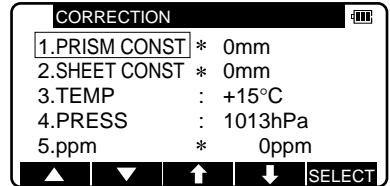

Press [F4] [↵] to move the cursor to “3.TEMP” and press the [F5] [SELECT] to enable the temperature to be changed.

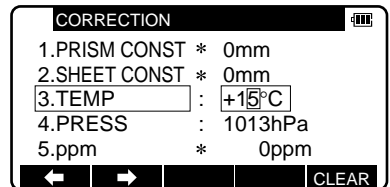

Clear the exiting values by pressing [CLEAR] key.  
 Input 22 by pressing the numeric keys.

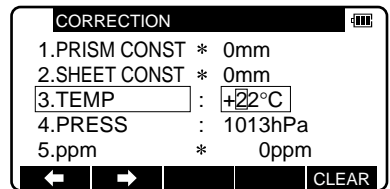

Press the [ENT] key to accept the Temperature to +22°C.

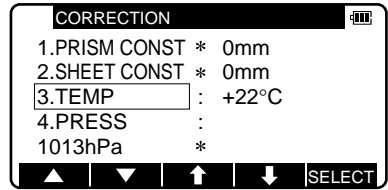

Pressing the [ENT] key returns the instrument to mode A.

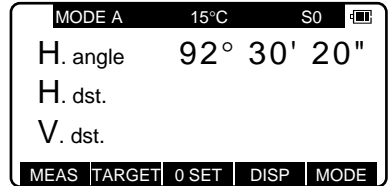

- The valid range of Temperature input is from -30°C to +60°C.
- When “Atmospheric Correction” in “Initial Setting 1” has been set to “1 . AUTO” or “4. NIL”, “\*” is displayed to the left of the temperature value on the correction menu screen. When “\*” is on the screen, the temperature cannot be changed. If “Atmospheric Correction” in “Initial Setting 1” has been set to “3. ppm INPUT”, no temperature is displayed on the correction menu screen.
- Once set, the temperature is displayed at the center of the top of the measurement screen.
- The factory initial of temperature is “1. AUTO”.
- Once set, the temperature remains in memory even after the power is turned off.
- Temperature correction is based on 15°C.  
If this instrument is used without correcting the temperature, a distance error per 100 m is about -0.1mm per +1°C as a temperature difference from 15°C. A distance error per 100 m is about 0.1 mm per -1°C as a temperature difference from 15°C. (For more accurate values, See page 82.)

## 7-3 Changing the Atmospheric Pressure

The atmospheric pressure setting can be changed only when “Atmospheric Correction” has been set to “ATM INPUT” in “Initial Setting 1”.

Example: Setting the pressure to 900 hPa

Press [F4] [CORR] in mode B.  
(If the instrument is in mode A, press [F5] [MODE] to enter mode B.)

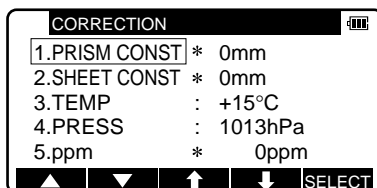

Press [F4] [↵] to move the cursor to “4.PRESS” and press the [F5] [SELECT] to enable the temperature to be changed.

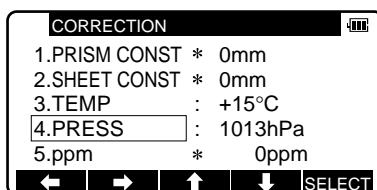

Clear the exiting values by pressing [CLEAR] key.

Input 900 by pressing the numeric keys.

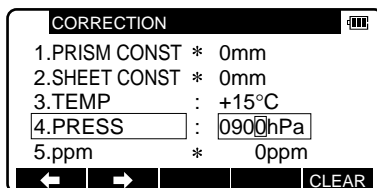

Press the [ENT] key to accept the PRESS to 900 hPa.

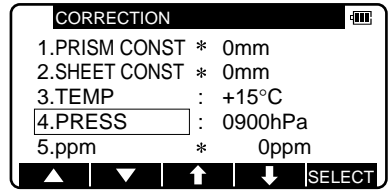

Pressing the [ENT] key returns the instrument to mode A.

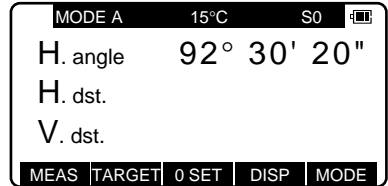

- The valid range of Pressure input is from 600 to 1120 hPa. (420 - 840 mmHg)
- When “Atmospheric Correction” in “Initial Setting 1” has been set to “1. AUTO” or “4. NIL”, “\*” is displayed to the left of the pressure value on the correction menu screen. When “\*” is on the screen, the pressure cannot be changed. If “Atmospheric Correction” in “Initial Setting 1” has been set to “3.ppm INPUT”, no pressure is displayed on the correction menu screen.
- Once set, the pressure is displayed at the center of the top of the measurement screen.
- The factory initial of pressure is “1. AUTO”.
- Once set, the pressure remains in memory even after the power is turned off.
- Pressure correction is based on 1013 hectopascals (hPa).
- If this instrument is used without correcting the pressure, a distance error per 100 m is about - 0.3 mm per -10 hPa as a pressure difference from 1013 hPa. (For more accurate values, see page 82.)

## 7-4 Changing the ppm Value

The ppm value can be changed only when “Atmospheric Correction” has been set to “ppm INPUT” in “Initial Setting 1”. “TEMP” and “PRESS” are not displayed.

Example: Setting the ppm value to 31 ppm

Press [F4] [CORR] in mode B.  
(If the instrument is in mode A, press [F5] [MODE] to enter mode B.)

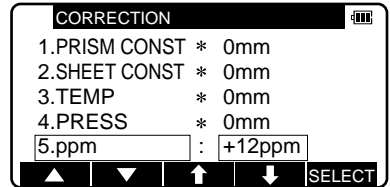

Press [F4] [↵] to move the cursor to “3. ppm” and press the [F5] [SELECT] to enable the temperature to be changed.

Press the [CLEAR] key.

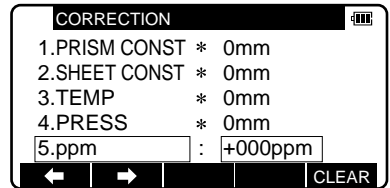

Input 31 by pressing numeric keys.

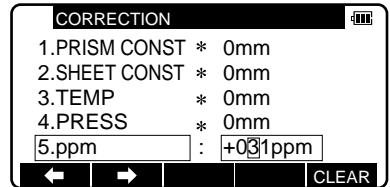

Pressing the [ESC] key returns the instrument to mode A.



- The valid range of ppm values is from -199 to +199.
- Once set, the ppm value is displayed at the center of the top of the measurement screen.
- The factory initial of ppm value is “1. AUTO”.
- Once set, the ppm value remains in memory even after the power is turned off.

# 8 INITIAL SETTING

## 8-1 Overview

For the R-300 series, you can select and save the desired setting for a variety of prescribed instrument conditions, called Initial Setting.

The Initial Setting is saved in four modes, "Initial Setting 1", "Initial Setting 2", "Initial Setting 4", and "Initial Setting 5", in which you can select and save the instrument conditions described below.

The factory default for each of these conditions is marked by .

To change Initial Setting, follow the operating procedures for entering each Initial Setting mode on Page 53 and the operating procedures for changing an Initial Setting on Page 55.

## 8-2 Entering the Mode for Initial Setting 1

Press the [POWER] key while holding [F1] key down to access the screen for Initial Setting 1.

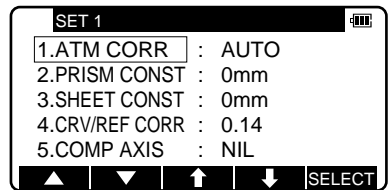

Press [F3] [↑] or [F4] [↓] to position the cursor at the item of interest.

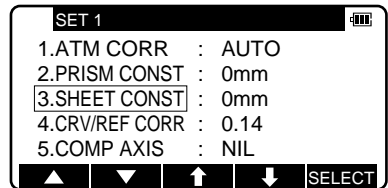

## 8-3 Entering the Mode for Initial Setting 2

Press the [POWER] key while holding [F2] key down to access the screen for Initial setting 2.

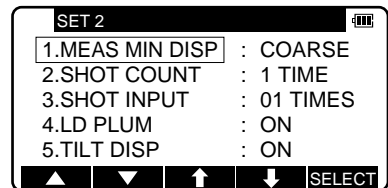

- Select the item of interest in the same way as in the mode for Initial setting 1.
- Pressing [F2] [▽] scrolls the screen down five items; pressing [F1] [△] scrolls it up five items.

## 8-4 Entering the Mode for Initial Setting 4

Press the [POWER] key while holding [F4] key down to access the screen for Initial setting 4.

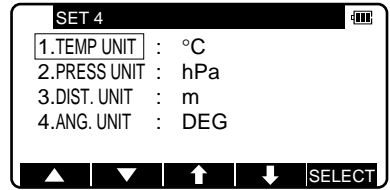

- Select the item of interest in the same way as in the mode for Initial setting 1.

## 8-5 Entering the Mode for Initial Setting 5

Press the [POWER] key while holding [F5] key down to access the screen for Initial setting 5.

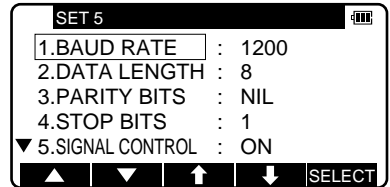

- Select the item of interest in the same way as in the mode for Initial setting 1.
- Pressing [F2] [▼] scrolls the screen down five items; pressing [F1] [▲] scrolls it up five items.



## 8-6 Example of Changing an Initial Setting Content (Selection of Atmospheric Correction)

This section describes the operating procedures for selecting “1.ATM CORR” in Initial Setting 1 as an example of changing an Initial Setting content. Use this example as a reference when changing other items because it is also applicable to the operating procedures for changing them.

Access the screen for Initial Setting 1 by taking procedures “Entering the Mode for Initial Setting 1” on page 50.

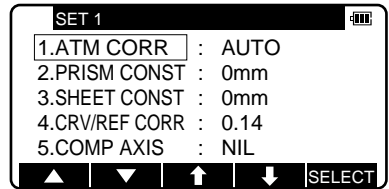

Press [F5] [SELECT] to open the screen for selecting the atmospheric correction.

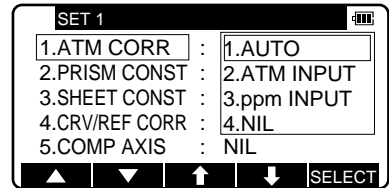

Press [F3] [↑] or [F4] [↓] to position the cursor at the desired item, then press [ENT] key to select that item.

Pressing the [ENT] key settles the change of selected item. Pressing the [ESC] key invalidates the change of selected item.

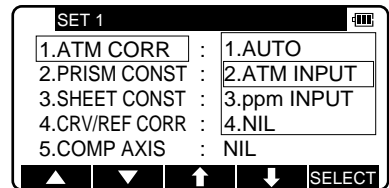

Pressing again the [ESC] key or [ENT] key quits the initial setting screen and usual start screen appears.

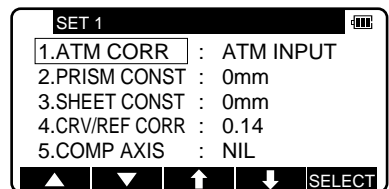

## 8-7 Initial Setting 1

1. Selection of **Atmospheric Correction** : [ATM CORR]

Select whether Atmospheric Correction is to be performed by using the automatic measurement correction function with a atmospheric sensor, by entering the atmospheric temperature and pressure measured with a thermometer and barometer, by entering ppm value, or by fixing the ppm value to 0 (NIL) not to perform Atmospheric Correction.

- 1.
- 2. ATM INPUT
- 3. ppm INPUT
- 4. NIL

2. Selection of **Prism Constant** : [PRISM CONST]

Select whether the Prism Constant to be input is set to 0 mm, - 30mm or to an arbitrary value to be entered from the keyboard.

- 1.
- 2. 0mm
- 3. INPUT

3. Selection of **Reflector sheet Constant** : [SHEET CONST]

Select whether the target constant to be input is set to 0 mm, or to an arbitrary value to be entered from the keyboard.

- 1.
- 2. INPUT

4. Selection for **Refraction & Curvature Corrections** : [CRV/REF CORR]

Select whether the correction factor to be input for both differences (Refraction, Curvature) is set to 0.14, 0.2, or none (NIL). Selecting "3. NIL" results in no correction of both values.

- 1.
- 2. 0.2
- 3. NIL

5. Selection of **Tilt Compensation** : [COMP AXIS]

Select whether Tilt Compensation is to be single-axis compensation, dual-axis compensation, or disabled (NIL). 3 AXIS selection is for R-322 (N)/R-323 (N).

- 1.
- 2. 2 AXIS
- 3. 1 AXIS
- 4. NIL

- 1.
- 2. 1 AXIS
- 3. NIL

- The factory default for each instrumet condition is marked by

## 8-8 Initial Setting 2

1. Selection of **Minimum Distance measurement unit** :  
[MEAS. MIN DISP]  
COARSE or FINE:

1. COARSE  
2. FINE

2. Selection of the **Shot count** : [SHOT COUNT]  
Select whether the shot count for Shot distance measurement is to be 1,3, 5, or an arbitrary count to be entered.

1. 1 TIME  
2. 3 TIMES  
3. 5 TIMES  
4. INPUT

3. Setting the **Shot input** : [SHOT INPUT]  
Set the shot number for Shot distance measurement.

01 TIMES

- The valid range of values for the shot number is from 1 to 99.
- This setting is enabled only when the shot number (Above 2.) has been set to "4. INPUT".

4. Selection of **Laser plummet** : [LD PLUM.]  
Laser plumb ON/OFF is selected.

1. OFF  
2. ON

5. Selection of **Tilting angle display** : [TILT DISP.]  
X and Y tilting values are displayed.

1. OFF  
2. ON

6. Selection for **Minimum tilt display** : [TILT DISP. UNIT]  
COARSE or FINE:

1. COARSE  
2. FINE

7. Selection of **Reflectorless range** : [RANGE]  
If you need the Normal or Long range.

1. NORMAL  
2. LONG

8. Selection of **Long range message** : [MESSAGE]  
If you need the long range message.

1. ON  
2. OFF

9. Selection of **Long range setup** : [SET UP]  
If the above No.7 selection is required each time or permanent.

1. EACH TIME  
2. PERMANENT

10. Selection of **primary MEAS setting** : [PRIM. MEAS KEY]

Select whether the primary distance measurement is MEAS SHOT or MEAS CONT or TRACK SHOT or TRACK CONT.

1. MEAS SHOT
2. MEAS CONT
3. TRACK SHOT
4. TRACK CONT

11. Selection of **second MEAS setting** : [SEC. MEAS KEY]

Select whether the second distance measurement is TRACK CONT or TRACK SHOT or MEAS CONT or MEAS SHOT.

1. TRACK CONT
2. TRACK SHOT
3. MEAS CONT
4. MEAS SHOT

12. Selection of **Minimum angle display** : [MIN UNIT ANG]

Select whether to set the minimum angle display mode to "COARSE (5 seconds)" or "FINE (1 second)".

1. COARSE
2. FINE

13. Selection of **Vertical angle style** : [V. ANG. STYLE]

Select whether the 0 point for vertical angle is set to be "Z.0", "H.0" or "COMPAS".

1. Z. 0
2. H. 0
3. COMPAS

14. Selection for **Automatic power-off function** :

[AUTO OFF]

Select the time interval (10, 20, or 30 minutes) for activating the automatic power-off function, or select NIL, disabling the function.

1. 10 MIN
2. 20 MIN
3. 30 MIN
4. NIL

- The automatic power-off function automatically turns the power supply off after the specified period of time (in minutes) when no operation for distance measurement or for key entry has been performed with the angle remaining unchanged.

15. Selection for **Distance measurement automatic power-off function** : [EDM OFF]

Select the time interval (3, 5, or 10 minutes) for activating the distance measurement automatic power-off function, or select NIL, disabling the function.

1. 3 MIN
2. 5 MIN
3. 10 MIN
4. NIL

- The distance measurement automatic power-off function automatically power-off distance measurement after the specified period of time when no key operation has been performed with the measured value remaining unchanged (over about 0.1 m) during measurement.

16. Selection for **Automatic illumination power-off**

**function** : [ILLU. OFF]

Select the time interval (3, 5, or 10 minutes) for activating the automatic illumination power-off function, or select NIL, disabling the function.

- |           |
|-----------|
| 1. 3 MIN  |
| 2. 5 MIN  |
| 3. 10 MIN |
| 4. NIL    |

17. Selection for **Distance measurement buzzer** :

[DIST. BUZ]

Select whether to enable or disable the beep when the prism receives a light during distance measurement or during repeated distance measurement.

- |        |
|--------|
| 1. ON  |
| 2. OFF |

18. Selection for **H. angle 90° buzzer** : [QUAD BUZ]

Select whether to enable or disable the beep at every 90° during angle measurement.

- |        |
|--------|
| 1. OFF |
| 2. ON  |

19. Selection of **Distance measurement signal** :

[MEAS. SIGNAL]

Select whether to display a signal indicator or AIM value to be displayed from when distance measurement is started to when measured data is displayed.

- |          |
|----------|
| 1. MARK  |
| 2. VALUE |

20. Selection of **Automatic distance measurement** :

[AUTO MEAS.]

Automatic distance measurement repeats measurement automatically when the telescope has been collimated at the prism. Select NIL, MEAS or TRACK.

- |          |
|----------|
| 1. NIL   |
| 2. MEAS  |
| 3. TRACK |

21. Selection for **priority Display** : [PRIORITY DISP]

Select the display order of the sets of display items which pressing the [DISP] key cycles through. The set of display items selected here appears first after the power is turned on.

- |                      |
|----------------------|
| 1. HA HD VD          |
| 2. HA VA SD          |
| 3. HA VA HD<br>SD VD |

22. Selection of the **Coordinate axis as XYZ, YXZ, NEZ or ENZ** : [COORD.AXIS]

Select the coordinate axis as XYZ, YXZ, NEZ, ENZ. This [COORD.AXIS] is only for the PSF software.

- |        |
|--------|
| 1. XYZ |
| 2. YXZ |
| 3. NEZ |
| 4. ENZ |

## 8-9 Initial Setting 4

1. Selection of **Temperature unit setting** : [TEMP. UNIT]

Select °C or °F as the unit for Temperature.

1. °C

2. °F

2. Selection of **Pressure unit setting** : [PRESS UNIT]

Select hPa (hectopascal) , mmHg, inchHg as the unit for pressure to be input.

1. hPa

2. mmHg

3. inchHg

3. Selection of **Distance unit setting** : [DIST. UNIT]

Select m or ft or ft+inch as the unit for Distance.

1. m

2. ft

3. ft+inch

4. Selection of **Angle unit setting** : [ANG. UNIT]

Select DEG or DEC or GRD or MIL as the unit for Angle.

1. DEG

2. DEC

3. GRD

4. MIL

## 8-10 Initial Setting 5

1. Selection of **Transfer rate (baud rate)** : [BAUD UNIT]  
Select a baud rate of 1200, 2400, 4800, or 9600.

1. 1200  
2. 2400  
3. 4800  
4. 9600

2. Selection of **Data bits** : [DATA LENGTH]  
Select a data length of 8 bits or 7 bits.

1. 8  
2. 7

3. Selection of **Parity** : [PARITY BITS]  
Select no (NIL) parity bit, even parity, or odd parity.

1. NIL  
2. EVEN  
3. ODD

4. Selection of **Stop bit** : [STOP BITS]  
Select the number of stop bits to be used: 1 or 2.

1. 1  
2. 2

5. Selection of **Control signal** : [SIGNAL CONTROL]  
Select whether the control signal is effective or not.

1. ON  
2. OFF

6. Selection of **XON/XOFF** : [XON/XOFF]  
Select whether to enable or disable XON/XOFF.

1. ON  
2. OFF

7. Selection of **Through command** : [THROUGH  
COMMAND]  
Select whether to disable data output without receiving  
any data request command or enable the "a" to "f"  
command data output.

1. NIL  
2. a  
3. b  
4. c  
5. d  
6. e  
7. f

# 9 ACCESSING THE FUNCTIONS

## 9-1 Accessing by Help key

You can use the [HELP] key to display specific Initial Setting (such as the Prism Constant and Priority mode).

Press the [ILLU]+[ESC] key in mode A or B.

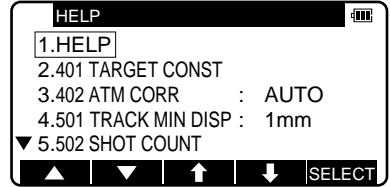

The help menu will then be displayed. Press [F1] [▲] [F2] [▼] or [F3] [⬆] [F4] [⬇] to position the cursor to the desired item.



## 9-2 Accessing by 007

The R-300 allows you to enter a special code of 007 with the Alphanumeric keys to display Specific Initial Setting. (such as the Prism Constant and Priority mode)

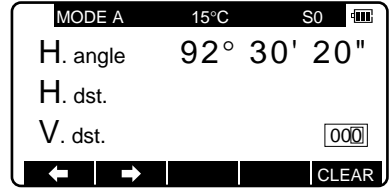

Press the numeric keys [0] [0] [7] in mode A or B. The screen will then change to the command input screen.

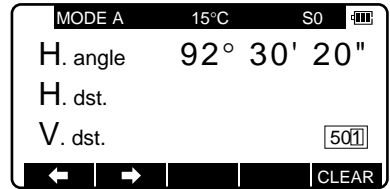

Press the numeric keys for the desired command number in the Command No. Table. (For example, press [5] [0] [1] for MEAS. MIN DISP.)

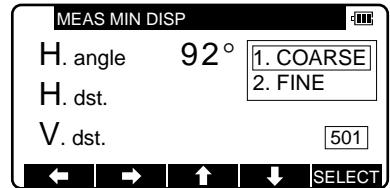

Press the [ENT] key to access the MEAS. MIN DISP.

**[Instrument setting items]**

007 code	HELP menu list		Default	Other options
401	TARGET CONST	PRISM CONST	-30mm	0mm, INPUT
		SHEET CONST	0mm	INPUT
402	ATM CORR		AUTO	ATM INPUT, ppm INPUT, NIL
501	MEAS. MIN DISP		COARSE	FINE
502	SHOT COUNT	SHOT CONT	1 time	3 times, 5 times, INPUT
		SHOT INPUT	01 times	(input)
503	CRV/REF CORR		0.14	0.2, NIL
504	MIN UNIT ANG.		COARSE	FINE
505	V. ANG. STYLE		Z.0	H.0, COMPASS
508	DIST.BUZ		ON	OFF
509	QUAD BUZ		OFF	ON
510	AUTO OFF		10 MIN	20 MIN, 30 MIN, NIL
511	EDM OFF		3 MIN	5 MIN, 10 MIN, NIL
512	ILLU.OFF		3 MIN	5 MIN, 10 MIN, NIL
514	MEAS.SIGNAL		MARK	VALUE
515	PRIORITY SELECT	PRIM.MEAS KEY	MEAS SHOT	MEAS CONT, TRACK SHOT, TRACK CONT
		SEC.MEAS KEY	TRACK CONT	TRACK SHOT, MEAS CONT, MEAS SHOT
		AUTO MEAS.	NIL	MEAS., TRACK
		PRIORITY DISP	HA/HD/VD	HA/VA/SD, HA/VA/HD/SD/VD
516	COORD.AXIS (for PSF software only)		XYZ	XYZ, NEZ, ENZ
517	COMP AXIS		3 Axis (2"/3" model) or 2 Axis	2 Axis (2"/3" model), 1 Axis , NIL
520	LD PLUM.&E.VIAL	LD PLUM.	OFF (LD plummet is OFF when Power On)	ON (automatically ON)
		TILT DISP.	OFF	ON
		TILT DISP.UNIT	COARSE	FINE
521	REF.LESS RANGE	RANGE	NORMAL	LONG
		MESSAGE	ON (when Range is LONG)	OFF
		SETUP	EACH TIME (w/ Power ON)	PERMANENT
701	ATM UNIT	TEMPUNIT	°C	°F
		PRESS UNIT	hPa	mmHg, inchHg
702	DIST.UNIT		m	ft, ft+inch
703	ANG.UNIT		DEG	DEC, GRD, MIL
801	SET UP COM.	BAUD RATE	1200	2400, 4800, 9600
		DATA LENGTH	8	7
		PARITY BITS	NIL	EVEN, ODD
		STOP BITS	1	2
		SIGNAL CONTROL	ON	OFF
		XON/XOFF	ON	OFF
		THROUGH COMMAND	NIL	a, b, c, d, e, f

# 10 CHECKS AND ADJUSTMENTS

- Checks and Adjustments should be performed before and during measurement.
- The instrument should be checked after long storage and transportation.
- The checks should be performed in the following order.

## [Cautions on CHECKS AND ADJUSTMENTS]

- When adjustment is completed, be sure that adjusting screws are completely tightened. When finishing turning adjusting screws, be sure that screws are turned in a direction for tightening.
- Repeat check after adjustment, and check if the instrument has been adjusted properly.
- When adjustment is completed, be sure that adjusting screws are completely tightened. When finishing turning adjusting screws, be sure that screws are turned in a direction for tightening.
- Repeat check after adjustment, and check if the instrument has been adjusted properly.

## 10-1 Electronic vial

### Checks

- ① Align the Electronic vial in parallel with a line joining any two of the leveling screws. Then, adjust the two screws to center the bubble in the Electronic vial. (A)
- ② Turn two leveling screws in an opposite direction mutually and have the bubble of the side of the electronic vial to the center.
- ③ Make the bubble of the length of the electronic vial to the center by operating the leveling screw of one remainder.
- ④ Rotate the instrument by 180° and confirm the position of the bubble of the electronic vial. At this time, it is not necessary to adjust it if the bubble of the electronic vial is in the vicinity of the center.

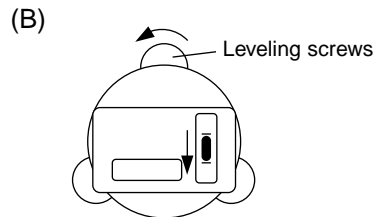
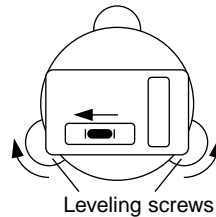

- Please check the electronic vial in a steady environment that has no vibration or rapid temperature change.
- When the electronic vial is checked outdoors and on a tripod, avoid sunlight influence by using a sunshade. Please wait for a while until the instrument and tripod are at the same temperature as the surrounding air.
- When the instrument is seen at the position of “Left circle”, movement and the inclination of the instrument become the same on the screen in the electronic vial. Please note that the movement of the bubble becomes opposite direction if it is seen at the position of “Right circle”.

## Adjustments

It is necessary to adjust as following when the bubble is not in the vicinity of the center in the confirmation of ④.

### Procedure to adjust the electronic vial:

Press the [POWER] and [LASER] key simultaneously.  
Following screen is viewed.

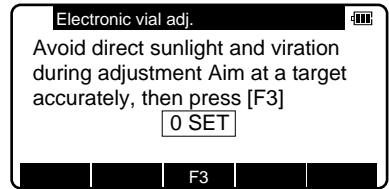

Aim at a target and press [F3] key.  
Following screen is viewed.

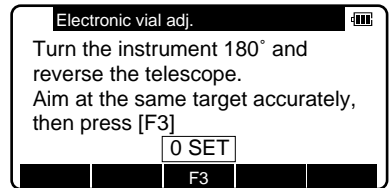

Turn the instrument 180° and reverse the telescope.  
Aim at the same target accurately, then press [F3].  
Following screen is viewed.

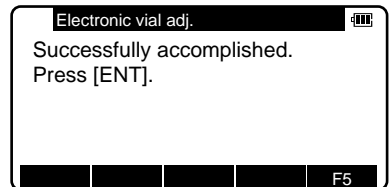

Pressing the [ENT] key completes the adjustment.

## 10-2 Circular Vial

### Checks

- ① Adjust by the electronic vial beforehand.
- ② Confirm the position of the bubble of the Circular vial.  
At this time, it is not necessary to adjust if the bubble is at the center of the circle.

### Adjustments

When the bubble of the Circular vial comes off from the center according to check procedure ②, it is necessary to adjust.

Turn the bubble adjustment screw with a hex wrench (L type wrench) and put the bubble in the center of the circle.

### [Only the detaching type model]

Turn the bubble adjustment screws with the reticle adjustment pin and put the bubble in the center of the circle.

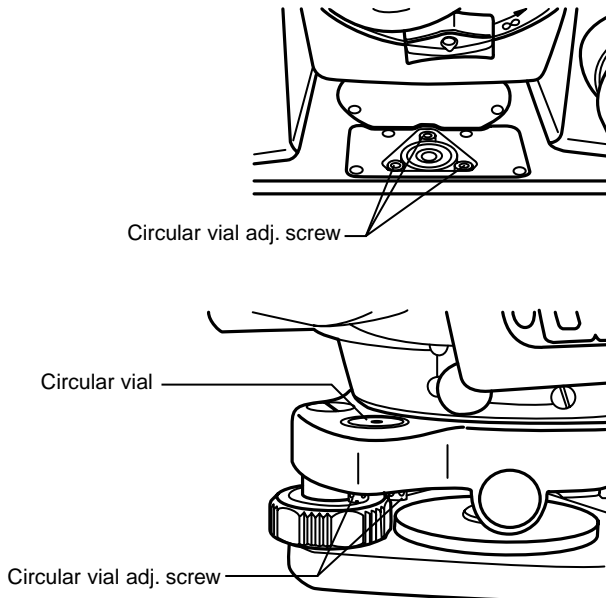

- Tighten the screws equally after the above adjustment.

## 10-3 Vertical Reticle

### Checks

- ① Set the instrument up the tripod and carefully level it.
- ② Sight the target Point A with telescope.
- ③ Using the telescope fine adjustment screws, move Point A to the edge of the field of view by screw (point A').
- ④ No adjustment is necessary if Point A moves along the vertical line of the reticle.

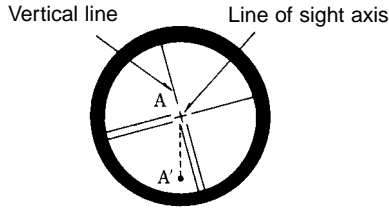

### Adjustments

- ① If Point A is off from the vertical line of the reticle, first remove the eyepiece cover.
- ② Using the adjusting pin, loosen the four reticle adjustment screws slightly loosening each screw by the same amount, and then rotate the reticle line around the sight axis and align the vertical line of the sight axis with Point A'.
- ③ Tighten the reticle adjustment screws again by the same amount, and repeat the check to make sure the adjustment is correct.

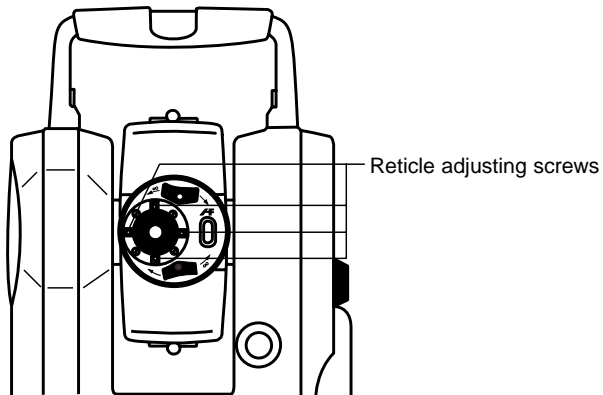

## 10-4 Perpendicularity of Line of sight to horizontal axis

### Checks

- ① Position a target Point A at a distance 30m - 50m away from the instrument, and sight it with the telescope.
- ② Loosen the telescope lock screw and turn the telescope until a point is sighted at a distance roughly equal to that of Point A. This is Point B.
- ③ With the telescope still reversed loosen the horizontal lock screw and rotate the instrument around the vertical axis, and sight Point A again.
- ④ Loosen the telescope lock screw and turn the telescope until a point is sighted at a distance equal to that of Point B. This is Point C.
- ⑤ No adjustment is necessary if Point B and C are aligned.

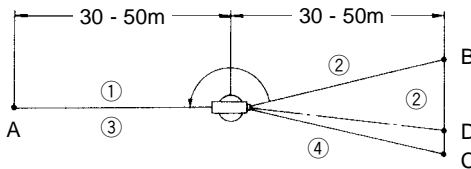

### Adjustments

- ① If Points B and C are not aligned, mark Point D at 1/4 the length of the BC, from Point C in the direction of Point B.
- ② Using the adjustment pin, rotate the reticle adjustment screws horizontally opposite each other (see preceding page), and move the reticle to sight Point D.
- ③ Repeat the check and make sure the adjustment is correct.

## 10-5 Vertical 0 point error

Be sure to follow check procedures mentioned below after making adjustments on reticle and perpendicularity of line of sight to horizontal axis.

### Checks

- ① Set up the instrument and turn the power on.
- ② Sight the telescope at any reference target A at Normale state. Read the vertical angle ( $\gamma$ ).
- ③ Turn the telescope and rotate the alidade. Sight the same target A again at Back state and read the vertical angle R.
- ④ If  $\gamma+R = 360^\circ$ , no further adjustment is necessary.

### Adjustments

If the deviation  $d (\gamma+ R - 360^\circ)$  is wide, contact your local dealer.



## 10-6 Laser Plummet

### Checks

- ① Set the instrument on the tripod, and place a piece of white paper with a cross drawn on it right under the instrument.
- ② Press the [LASER] key, and move the paper so that the intersecting point of the cross comes to the center of the Laser mark.
- ③ Rotate the instrument around the vertical axis, and observe the center mark position against the intersecting point of the cross at each 90° rotation.
- ④ If the Laser mark always coincides with the intersecting point, no adjustment is necessary.

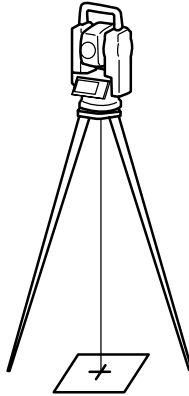

### Adjustments

When a center part where a cross intersection and the laser mark look the brightest shifts by 0.8mm or more (at the instrument height 1.5m), it is necessary to adjust it. A repair engineer does this adjustment. Please contact the PENTAX dealer.

## 10-7 Optical Plummet

### Checks

- ① Set the instrument on the tripod, and place a piece of white paper with a cross drawn on it right under the instrument.
- ② Look through the optical plummet, and move the paper so that the intersecting point of the cross comes to the center of the field of view.
- ③ Adjust the leveling screws so that the center mark of the optical plummet coincides with the intersecting point of the cross.
- ④ Rotate the instrument around the vertical axis. Look through the optical plummet each  $90^\circ$  of rotation, and observe the center mark position against the intersecting point of the cross.
- ⑤ If the center mark always coincides with the intersecting point, no adjustment is necessary.

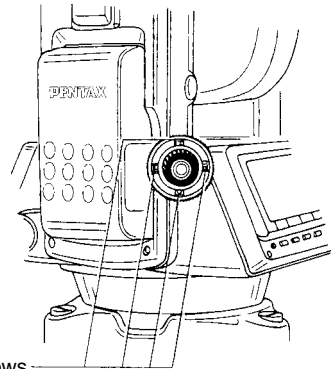
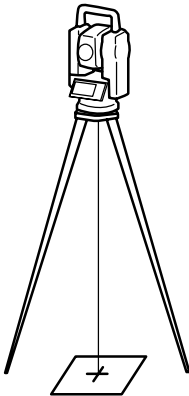

### Adjustments

- ① If the center mark does not coincide with the intersecting point, rotate the optical plummet focusing knob cover and remove it.
- ② Mark the point set on the line of sight at each step of  $90^\circ$  on the white paper and call them A, B, C and D.
- ③ Join the opposed points (A,C and B,D) with a straight line, and set the intersecting point 0.
- ④ Turn the four optical plummet adjusting screws with an adjusting pin so that the center mark coincides with the intersecting point 0.
- ⑤ Repeat from ④, and check that adjustment is correct.

## 10-8 Offset Constant

The offset constant rarely changes. It is recommended, however, that check be done once or twice a year.

The check of the offset constant can be done on a certified base line. It can also be obtained in a simple way as described below.

### Checks

1. Locate points A, B and C at about 50m intervals on even ground.
2. Set up the instrument at point A, and measure the distances between AB and AC.
3. Set up the instrument at point B, and measure the distance BC.
4. Obtain the offset constant (K):

$$K=AC - (AB+BC)$$

### Adjustments

- Contact your local dealer for adjustment of the off-set constant when the K is not nearly 0.

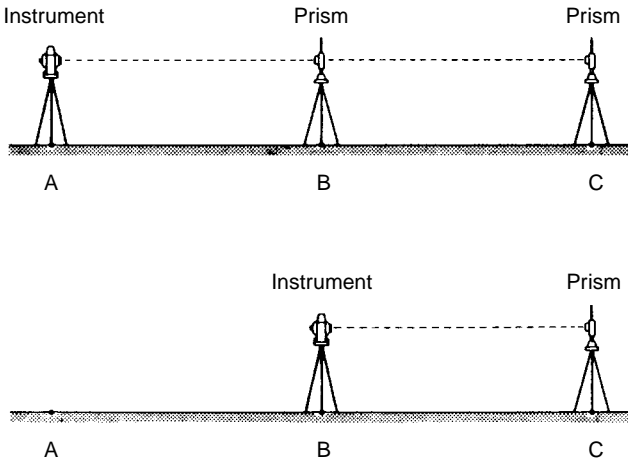

## 10-9 Beam axis and Line of sight

Be sure to check that the beam axis and line of sight are aligned when the adjustments on reticle and perpendicularity of line of sight to horizontal axis are made.

### Checks

- ① Set the prism at a distance greater than 50 m.
- ② Accurately sight the center of the prism through the telescope.
- ③ Turn the power on and press (MEAS) to measure.
- ④ No adjustment is necessary if beam receiving buzzer sounds immediately and measurement value is displayed in a few seconds.

### Adjustments

- If instrument function is not as described in ④, contact your local dealer.
- This check should be done under good weather conditions.

## 10-10 The EDM beam axis

The distance measurement (EDM) beam axis is adjusted to be aligned to the sighting axis of the telescope, but it can be changed a little in case of rapid temperature change, shock or aging. Check your instrument by following procedures.

### Checks

- ① Install the instrument on the tripod and level it at the distance of approx. 50 m from the wall.
  - ② Displace the target plate attached to the end of this manual. Place the target plate adjusting its center to the center of telescope cross line and to be about horizontal to the instrument.
  - ③ Turn the power on, and confirm the [TARGET] is set to the Reflecting sheet mode (“S” will be indicated at the top of display, left side of the battery remains sign when it is that.) When it is not, press [F2] [TARGET] and set to Reflecting sheet mode (Reference p38 6.1 Target Setting).
  - ④ Press [F1] [MEAS], then the laser spot appears on the target plate. If the “Center” of the laser spot is within the internal circle (10mm) of the target plate at this moment, the adjustment is unnecessary.
- The laser spot disappears in approx. 20 seconds after pressing [F1][MEAS]. Press [MEAS] again, if it is necessary.

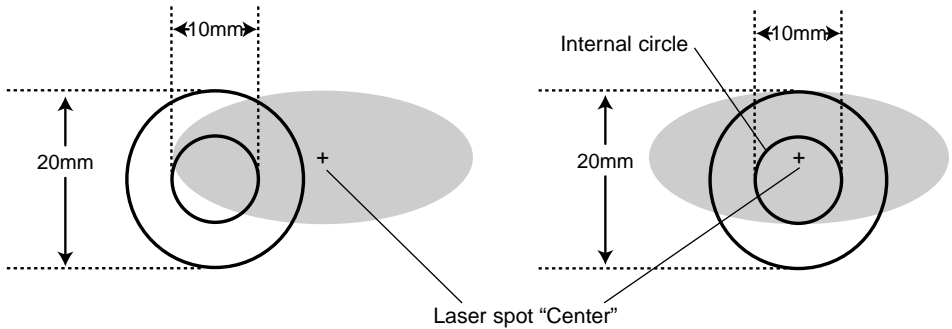
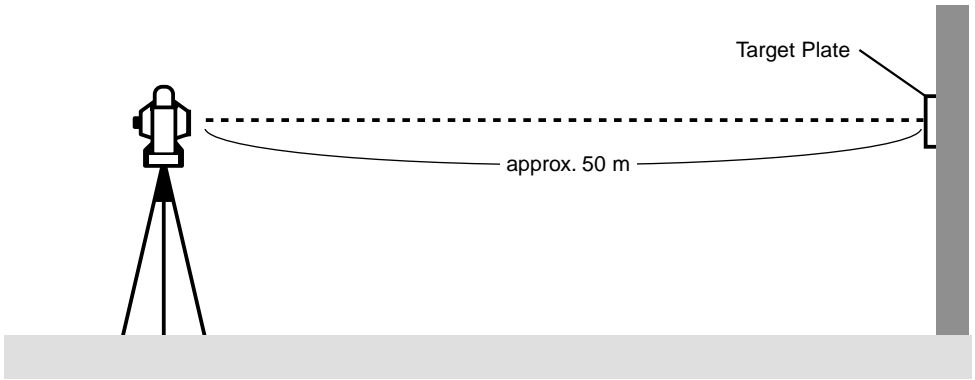

[Example: Adjustment is necessary]

[Example: Adjustment is unnecessary]

## Adjustments

At the procedure 4. above, if the "Center" of laser spot is not within the internal circle (10mm) of the target plate, the adjustment is necessary. Please contact your PENTAX dealer.

# 11 SPECIFICATIONS

Reflectorless items are applicable to “N” models only.

	R-322 (N)	R-323 (N)	R-325 (N)	R-335 (N)	R-315 (N)	R-326
<b>Telescope</b>						
Image	Erect					
Optical aperture	45mm					
EDM aperture	45mm					
Reticle illumination	Intensity settings: 10 steps					
Auto & Power focus	Yes					No
Method	Phase differential					---
Power	By main battery					---
Pointer	Visible laser					
Magnification	30 x					
Resolving power	3"					
Field of view	2.6% (1° 30')					
Minimum focus	1.0m					
Auto-Focus	Auto-focus / Power Focus / Manual					Manual
<b>Distance measurement</b>						
Laser Class	Visible Laser: Class II (2) / Class IIIa (3R) -Long range mode in Reflectorless					
<b>Measurement range (Good condition)</b>						
Reflectorless	1.5m -Normal range mode: 70m (90m) / Long range mode 150m(180m)					—
Reflector sheet	1.5m - 600m (800m)					
Mini prism	1.5m - 1100m (1600m)					
1P	1.5m - 3400m (4500m)	1.5m - 3000m (4000m)			1.5m - 2000m (2800m)	
3P	200m - 4500m (5600m)	200m - 4000m (5000m)			200m - 2800m (3500m)	
<b>Accuracy</b>						
Prism	±(2+2ppm x D)mm	±(3+2ppm x D)mm	±(5 + 3ppm x D)mm			
Reflector Sheet	±(2+2ppm x D)mm	±(3+2ppm x D)mm	±(5 + 3ppm x D)mm			
Reflectorless	±(5 + 2ppm x D)mm		±(5 + 3ppm x D)mm			—
At Auto-Atm. Correction	Prism, Ref.sheet: ±(3 +10ppm x D)mm / Reflectorless: ±(5 +10ppm x D)mm					
<b>Measuring time (minimum count)</b>						
Fine	2.5sec. (0.1mm)					
Normal	1.5sec. ( 1 mm)					
Track	0.4 sec. ( 1 cm)					

	R-322 (N)	R-323 (N)	R-325 (N)	R-335 (N)	R-315 (N)	R-326
<b>Angle measurement</b>						
Measuring method	Absolute rotary encoder					
Detection	2 sides					
Minimum count	1" (2cc) / 5" (10cc) selectable					
Accuracy (DIN18723)	2"	3"	5"			6"
Compensator	Triple axis			Dual axis		
Tangent screw	2 speed			1 speed		
<b>Sensitivity of vials</b>						
Plate level (electronic)	30"/1div.					40"/1div.
Circular level	8'/2mm					
Plummet	Visible Laser, $\pm 0.8$ mm (instrument height 1.5m)					
Base	Detachable			Shifting	Fixed	Detachable
Water resistant	IPx6					
Ambient temperature	-20°C ~ +50°C / -4°F ~122°F (Working range)					
Tripod thread	5/8" x 11			35mm x 2		5/8" x 11
<b>Dimensions/Weight</b>						
Instrument	172(W) x 343(H) x 440(L) mm					
Weight (incl. Battery)	5.7 kg			5.5 kg	5.7 kg	
Carrying case	268(W) x 442(H) x 465(L) mm/3.9kg					
<b>Battery pack BP02</b>						
Power source	Ni-MH (Rechargeable)(4300mAh) , DC6V					
Operation time	Continuous Approx. 5 hrs (ETH+EDM), 12 hrs (ETH) with Approx. 2.2 hrs of charging time					
Weight	Approx. 380g					
<b>Charger BC03 and AC Adapter AC01</b>						
Input voltage	DC16V , 100~240V					
Output voltage	DC7.5V/ 9V , DC16V					
Weight	280g					
<b>Internal Memory</b>						
Coordinates data	7500 points (Measured and input coordinate data)					

Note: Reflector sheet: By PENTAX genuine Reflector sheet (5cm x 5 cm)

- Normal conditions: 20km visibility with slight shimmer
- (Good conditions): 40km visibility, overcast, no heat no shimmer and moderate wind
- Reflectorless The measurement range and accuracy are determined by the white side of the Kodak Gray Card.
- The measurement range at TRACK mode by Reflectorless mode is over 5m.
- The measurement range may vary by measurement conditions.

# 12 DATA COLLECTOR

The instrument can communicate directly with a computer through the RS232C interface. By use of a data collector you can automate data entry from the collection of survey data to the transfer of the data to a computer. This is useful in saving time and protecting data integrity.

- About connection with data collector and the handling, please refer to an "Instruction manual" of the data collector.
- Connecting a data collector to a computer is different with every system. Please contact your local dealer about them.



# 13 APPENDIX

## 13-1 Error Messages

Message	Meaning	What to do
Out of tilt range	Displayed when the instrument is tilted beyond the vertical compensation range ( $\pm 3'$ ) in case 1 axis or 2 axis automatic compensation is selected. This message may be temporarily displayed if the instrument is turned too fast.	Re-level the instrument. Repair is needed if the message is displayed when it is properly leveled.
Excess data	The input data exceeds the allowable range.	Press the [ESC] key and enter the correct data.
Mismatched Target	<ul style="list-style-type: none"> <li>● The distance is measured by Prism at Reflector sheet mode, and the distance is over than 1000m.</li> <li>● The distance is measured by Prism or Reflector sheet at Reflectorless mode, and the distance is over than 200m.</li> </ul>	Select the correct target mode.
Target is too close.	<ul style="list-style-type: none"> <li>● The measurement distance is less than 1.5m at Reflector sheet mode.</li> <li>● The measurement distance is less than 1.5m at Prism mode.</li> </ul>	Select a longer point, or use a tape measure.
Unsuitable Condition	<ul style="list-style-type: none"> <li>● Under too strong sun light.</li> <li>● Unstable light value owing to shimmer or obstacles.</li> <li>● Reflector sheet, Target and Prism do not face the instrument.</li> <li>● Reflector sheet, Target and Prism are not correctly sighted.</li> <li>● Measurement range is over at Reflectorless mode.</li> <li>● Sufficient signal does not return by sighting sharp edge etc. at Reflectorless mode.</li> </ul>	Change the object that has much better reflectivity, or use a reflecting sheet, or wait until the sun activity has weakened.
ERROR!! EDM ERROR 04 -05, 34-39, 50-53	Distance measurement system problem	Turn the power off, and then turn on again. Repair is needed when the message appears consistently.
ERROR!! ETH ERROR 70- 76	Angle measurement system problem	
ERROR!! ETH ERROR 19	Memory problem	
ERROR S DATA of EDM	Problem of the internal EDM parameters	
ERROR P DATA of EDM		
ERROR ETH DATA	Problem of the internal ETH parameters	

## 13-2 Atmospheric Correction

The speed at which light travels through the air varies depending on the temperature and atmospheric pressure. The R-100 series is designed to measure distances at the speed of light in order to measure accurately, Atmospheric Correction needs to be used. The instrument is designed to correct for weather conditions automatically if the temperature and pressure are input. Correction is then carried out based on the following formula.

Calculation formula

$$K = \left( 276.26713 - \frac{78.565271 \cdot P}{273.14941 + t} \right) \times 10^{-6}$$

K: Atmospheric Correction Constant

P: Atmospheric pressure (hPa)

t: Temperature(°C)

Distance after Atmospheric Correction  $D = D_s (1+K)$

Ds: Measured distance when no Atmospheric Correction is used.

## 13-3 hPa and mmHg Conversion Table

### Converting from hPa to mmHg

hPa	0	10	20	30	40	50	60	70	80	90
500	<sup>mmHg</sup> 375	<sup>mmHg</sup> 383	<sup>mmHg</sup> 390	<sup>mmHg</sup> 398	<sup>mmHg</sup> 405	<sup>mmHg</sup> 413	<sup>mmHg</sup> 420	<sup>mmHg</sup> 428	<sup>mmHg</sup> 435	<sup>mmHg</sup> 443
600	450	458	465	473	480	488	495	503	510	518
700	525	533	540	548	555	563	570	578	585	593
800	600	608	615	623	630	638	645	653	660	668
900	675	683	690	698	705	713	720	728	735	743
1000	750	758	765	773	780	788	795	803	810	818
1100	825	833	840	848	855	863	870	878	885	893
1200	900	908	915	923	930	938	945	953	960	968

### Converting from mmHg to hPa

mmHg	0	10	20	30	40	50	60	70	80	90
400	<sup>hPa</sup> 533	<sup>hPa</sup> 547	<sup>hPa</sup> 560	<sup>hPa</sup> 573	<sup>hPa</sup> 587	<sup>hPa</sup> 600	<sup>hPa</sup> 613	<sup>hPa</sup> 627	<sup>hPa</sup> 640	<sup>hPa</sup> 653
500	667	680	693	707	720	733	747	760	773	787
600	800	813	827	840	853	867	880	893	907	920
700	933	947	960	973	987	1000	1013	1027	1040	1053
800	1067	1080	1093	1107	1120	1133	1147	1160	1173	1187
900	1200	1213	1227	1240	1253	1267	1280	1293	1307	1320

## 13-4 Error when no Atmospheric Correction is made

When measurement is carried out with no Atmospheric Correction (with the settings fixed at a temperature of 15°C and an atmospheric pressure of 1013 hPa or 760 mmHg), the Error per 100 meters in temperature and pressure will be shown in the tables below.

- When the actual pressure is 1013 hPa (760 mmHg) and the temperature is 25°C, conducting the measurement with the temperature left at 15°C will result in the measurement being short by 0.9 mm per 100 meters.

### Error table: When hPa (15°C, 1013hPa as standard)

Unit:mm

hPa C°	1200	1100	1013	900	800	700	600	500
45	2.0	-0.5	-2.6	-5.5	-8.0	-10.5	-13.0	-15.5
35	3.0	0.4	-1.8	-4.7	-7.3	-9.9	-12.5	-15.1
25	4.0	1.4	-0.9	-4.0	-6.6	-9.3	-12.0	-14.6
15	5.2	2.4	-0.0	-3.1	-5.9	-8.6	-11.4	-14.2
5	6.3	3.5	1.0	-2.2	-5.1	-8.0	-10.8	-13.7
-5	7.6	4.7	2.1	-1.3	-4.2	-7.2	-10.2	-13.1
-15	9.0	5.9	3.2	-0.2	-3.3	-6.4	-9.5	-12.6

### Error table: With mmHg (15°C, 760mmHg as standard)

Unit:mm

mmHg C°	900	800	760	700	600	500	400
45	2.0	-1.3	-2.6	-4.6	-8.0	-11.3	-14.6
35	3.0	-0.4	-1.8	-3.9	-7.3	-10.8	-14.2
25	4.0	0.5	-0.9	-3.1	-6.6	-10.2	-13.7
15	5.2	1.5	0.0	-2.2	-5.9	-9.6	-13.3
5	6.3	2.5	1.0	-1.3	-5.1	-8.9	-12.7
-5	7.6	3.7	2.1	-0.3	-4.2	-8.2	-12.2
-15	9.0	4.9	3.2	0.8	-3.3	-7.4	-11.5

## 13-5 Atmospheric Refraction and Earth Curvature Correction

- Atmospheric refraction and earth curvature correction refers to correcting both the bending of the light beam caused by atmospheric refraction and the effect on the height differential and horizontal distance caused by the earth curvature.
- Correction called “atmospheric refraction and earth curvature correction” is initiated to correct error when the slope distance and vertical angle are caused to determine the horizontal distance and the height differential, with this instrument, the following formula is used to correct these factors.
- Calculation formula when atmospheric refraction and earth curvature correction parameter is set to “ON”:

Corrected horizontal distance (H)

$$H = S \left( \cos\alpha + \sin\alpha \cdot \frac{K-2}{2Re} \cdot S \cdot \cos\alpha \right)$$

Corrected vertical distance (V)

$$V = S \left( \sin\alpha + \cos\alpha \cdot \frac{1-K}{2Re} \cdot S \cdot \cos\alpha \right)$$

- Calculation formula when atmospheric refraction and earth curvature correction parameter is set to “OFF”:

$$\begin{array}{ll} \text{Horizontal distance} & H' = S \cdot \cos\alpha \\ \text{Vertical distance} & V' = S \cdot \sin\alpha \end{array}$$

S: Slope distance

$\alpha$ : Vertical angle from horizontal

K: Atmospheric refraction coefficient (0.14 or 0.2)

Re: Diameter of earth (6,370 km)

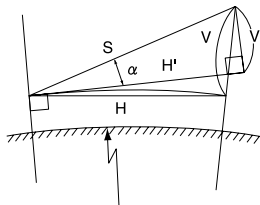

Re=6378137m(GRS1980)

## 13-6 Distance Range

Generally speaking, the maximum range which can be measured varies considerably depending on the atmospheric conditions. For this reason, the Specifications illustrate the values for both Good and Normal weather conditions. It is extremely difficult to judge when weather conditions are “Good” and when they are “Normal”. With this instrument, the conditions noted below are used to differentiate between the two situations, (Good weather conditions for surveying are different from Normal weather conditions, and in surveying situations, cloudy skies are considered more favorable than sunny skies.)

Weather conditions for measurement ranges are based on the following standard values:

Normal: Visibility of approximately 20 km, with slight shimmer and moderate wind.

Good: Visibility of approximately 40 km, overcast, with no shimmer and moderate wind.

# 14 NOTICE TO THE USER OF THIS PRODUCT

To assure compliance with the Safety standard 21 CFR, Chapter 1. Subchapter J. The U.S. bureau of Radiological Health requires the following information to be provided to user.:



It can be dangerous to look into the beam with optical equipment such as binoculars and telescopes.

- 1) Specifications of Laser Radiation
  - A) The EDM module of the R-300 produces a visible light beam, which is emitted from the telescope objective lens and the center hole of the instrument base plate. The R-300 is designed and built to have a laser diode radiating at 620-690 nm.
  - B) Radiant power  
The R-300 is designed and built to radiate a maximum average radiant power of 4.75mw. (0.95mw for the model without "N") from the telescope, and 0.95mw from the center hole of the base plate. The user may be subject to this radiation as a beam while operation until such time that the instrument is turned off.
- 2) The following labels are affixed to and must remain attached to this laser product.
  - A) The following Certification label is located near the Plate level.:  
"This laser product is complied with the provisions of 21 CFR 1040. 10 and 1040.11. For a Class II laser product."  
Or for R-300 N models:  
"This laser product is complied with the provisions of 21 CFR 1040. 10 and 1040.11. For a Class IIIa laser product."
  - B) Caution label is located near the exit aperture :  
"AVOID EXPOSURE Laser radiation is emitted from this aperture."
  - C) Warning logotype is located on the surface of the telescope:  
"CAUTION LASER RADIATION DO NOT STARE INTO BEAM"  
Or for R-300 N models:  
"DANGER LASER RADIATION AVOID DIRECT EYE EXPOSURE"
  - D) Warning label is Located near the exit aperture.
- 3) Caution to maintain the safety in compliance with the standard
  - A) To maintain the safety standard, refrain from any operation, maintenance, or adjustment other than described in this instruction manual.
  - B) Operation, maintenance or adjustment other than those specified in this instruction manual may result in hazardous radiation exposure.
  - C) Maintenance and repair not covered in this manual must be done by an authorized Pentax dealer.
  - D) The Laser beam emission by the Distance measurement can be terminated by pressing F1 MEAS key.
  - E) Pressing Laser key → F2 LD POINT key can terminate the laser beam emission by the laser pointer.
  - F) The Laser beam emission by the Laser plummet can be terminated by pressing Laser key.

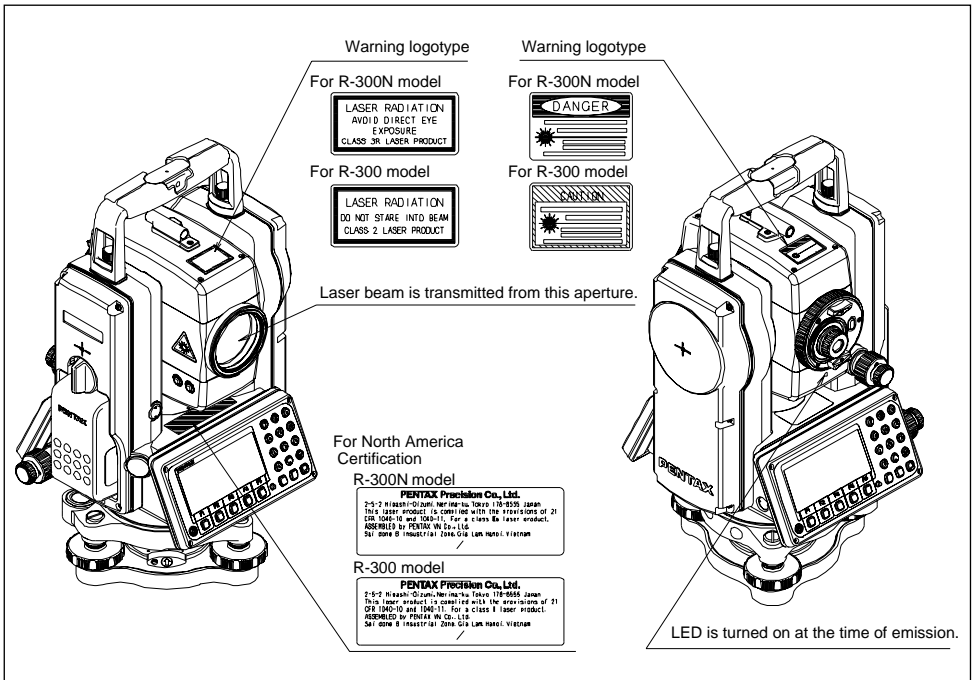
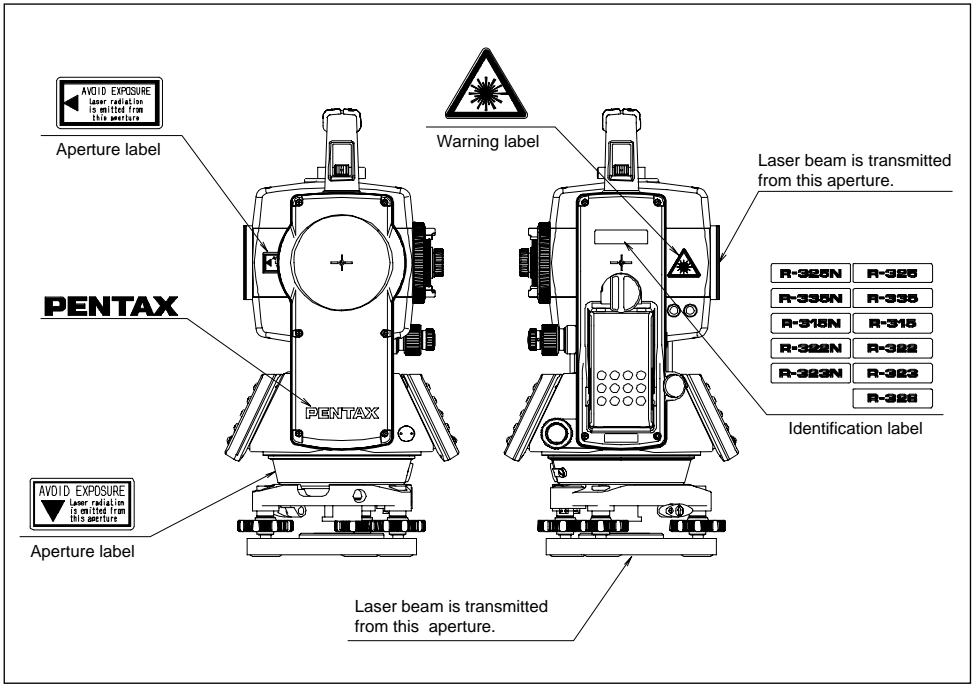



[TARGET PLATE]

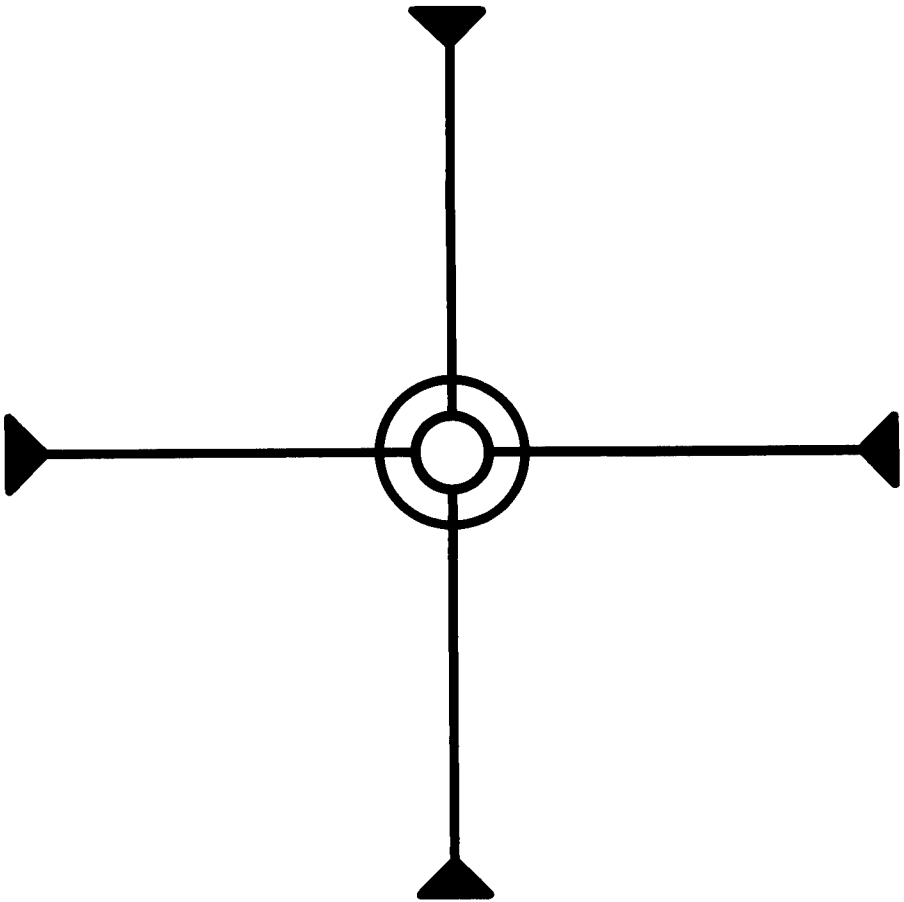



# **PENTAX®**

**PENTAX Precision Co., Ltd.**

2-5-2, Higashi-Oizumi, Nerima-ku,  
Tokyo, 178-8555, Japan  
Tel: +81-3-5905-1222  
Fax: +81-3-5905-1225



The CE marking assures that this product complies with the requirements of the EC directive for safety.

Member symbol of the Japan Surveying Instruments Manufacturers' Association representing the high quality surveying products.



10.2002 First Edition  
02.2003 Second Edition  
**TS01101E**